



SEDIAKREATIVE

COLLECTION



Shop1:
6, Charilaou Trikoupi
P.O.Box 61387
8133, Paphos - Cyprus
Mob: (+357) 99647447
Tel: (+357) 26811990
Fax: (+357) 26935566

Shop 2:
6, Anthypolochagou
Georgiou Savva, Shop A&B
8201, Geroskipou - Cyprus
Mob: (+357) 99647447
Tel: (+357) 26967600
Fax: (+357) 26967007

sedia@sedia.com.cy

www.sedia.com.cy

Categoria B
100% Polipropilene Ignifugo

Category B
100% Polypropylene F.R.

Composizione:
100% Polipropilene Ignifugo
Peso:
Gr/Mq 210,00

Composition:
100% Polypropylene Flame Retardant
Weight:
Gr/Sqm 210,00

Categoria M
100% Polipropilene Ignifugo

Category M
100% Polypropylene F.R.

Composizione:
100% Polipropilene Ignifugo
Peso:
Gr/Mq 350,00

Composition:
100% Polypropylene Flame Retardant
Weight:
Gr/Sqm 350,00

Categoria L
Trevira C.s. 100% Poliestere Ignifugo

Category L
Trevira C.s. 100% Polyester F.R.

Composizione:
100% Poliestere Ignifugo
Peso:
Gr/Mq 630,00

Composition:
100% Polyester Flame Retardant
Weight:
Gr/Sqm 630,00

Categoria H
100% Poliestere

Category H
100% Polyester

Composizione:
100% Poliestere
Peso:
Gr/Mq 310,00

Composition:
100% Polyester
Weight:
Gr/Sqm 310,00

Categoria C
100% Poliestere Ignifugo

Category C
Trevira C.s. 100% Polypropylene F.R.

Composizione:
100% Poliestere Ignifugo
Peso:
Gr/Mq 420,00

Composition:
100% Polyester Flame Retardant
Weight:
Gr/Sqm 420,00

Categoria V
Trevira C.s. 100% Poliestere Ignifugo

Category V
Trevira C.s. 100% Polyester F.R.

Composizione:
100% Poliestere Ignifugo
Peso:
Gr/Mq 490,00

Composition:
100% Polyester Flame Retardant
Weight:
Gr/Sqm 490,00

B

Tessuto Ignifugo
Polipropilene ignifugo
Flame retardant
Polypropilene FR



91

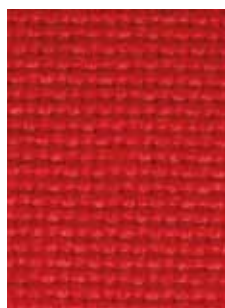

87

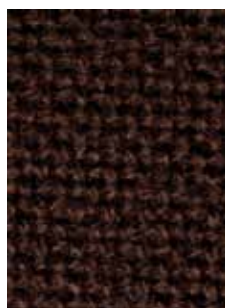

84

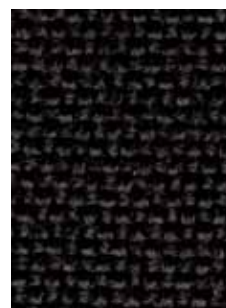

90



86



79



85

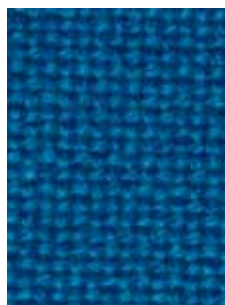

88

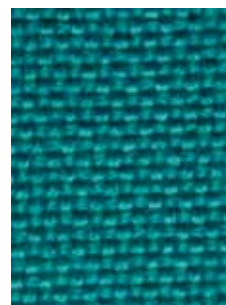

80



82

M

Tessuto Ignifugo
Polipropilene ignifugo
Flame retardant
Polypropilene FR

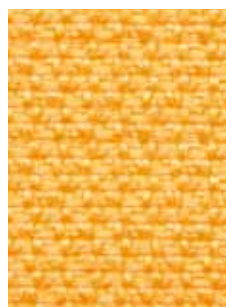

31

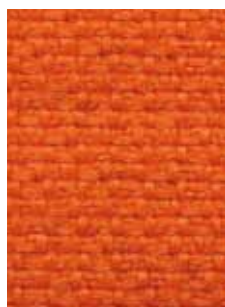

32



33

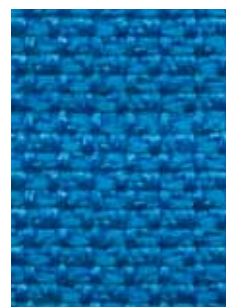

34

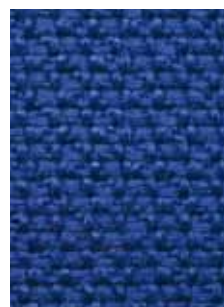

35

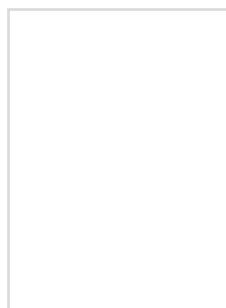

36

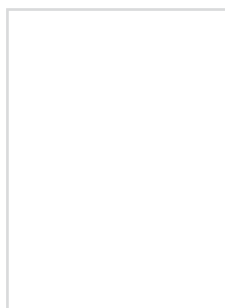

37

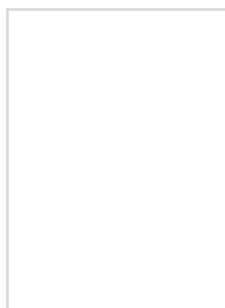

38

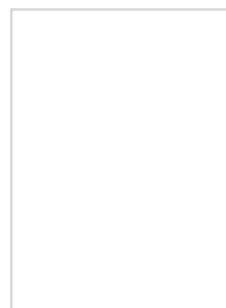

39

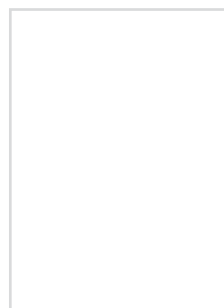

40

L

Poliestere ignifugo
Trevira C.s.
Polyester F.R.
Fabric Trevira C.s.



130



131



132



133



134

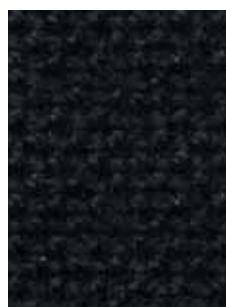

135

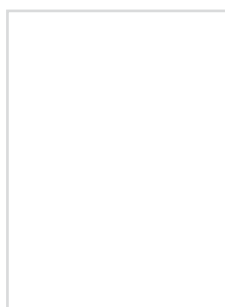

136

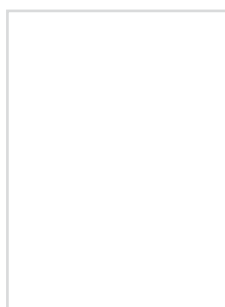

137

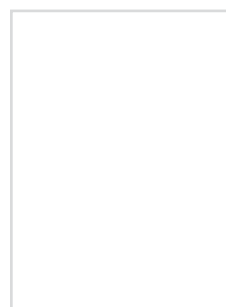

138

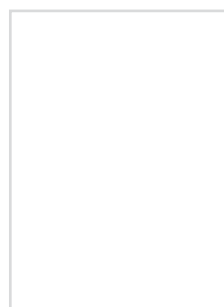

139

H

100% Poliestere
100% Polyester



93



94

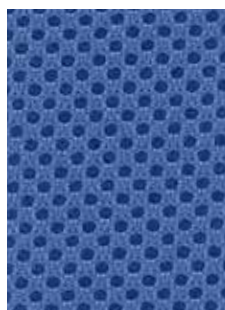

99



96



98

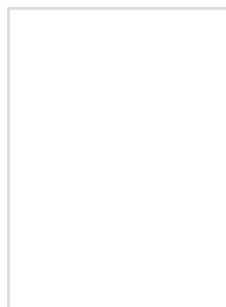

101

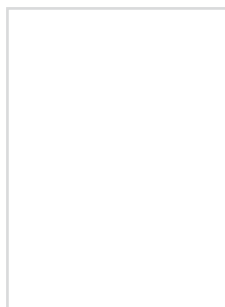

102

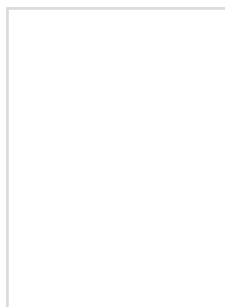

103

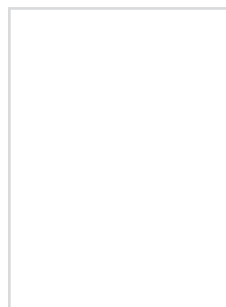

106

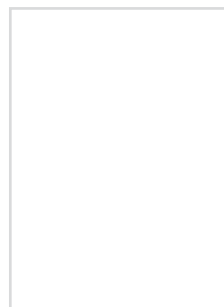

107

C

Poliestere ignifugo
Trevira C.s.
Polyester ignifugo
Fabric Trevira C.s.



211



212



213



214



215



216

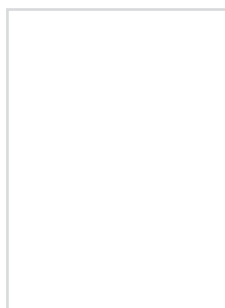

217

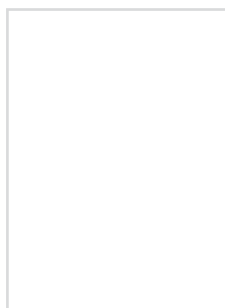

218

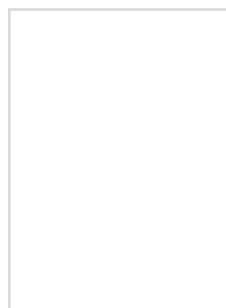

219

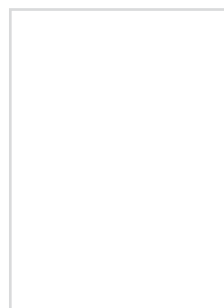

220

V

Poliestere ignifugo
Trevira C.s.
Polyester ignifugo
Fabric Trevira C.s.

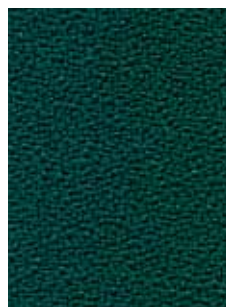

355



352



353



358



357

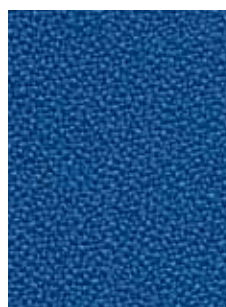

354



351



356

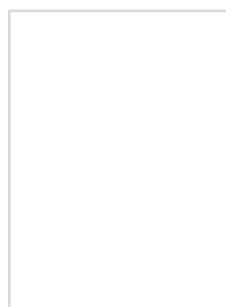

359

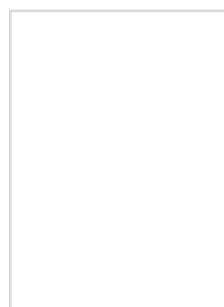

360



Oggi molte cose sembrano scontate.
Today, it seems as though many things are taken for granted.

Ma all'inizio c'è sempre stata un'iniziativa, un'idea, un'innovazione che ha permesso ai prodotti di funzionare e apparire come sono oggi.

Se si cercano le origini, si approda immancabilmente a parecchi anni fa, quando è stata ideata la prima sedia girevole con ammortizzatore, nonché la prima sedia a cinque razze con rotelle piroettanti.

Anche con lo schienale dinamico, sono stati definiti nuovi standard, ancora oggi utilizzati a livello internazionale.

Le sedie girevoli con meccanismo sincronizzato e dispositivi up-down sono oggi fra le più confortevoli e affidabili del mondo.

There was always an initiative, an idea or innovation in the beginning which allowed for products to work and appear as they are today. If you search for the origins, you find yourself unfailingly brought back in time, when the first swivel chair with shock absorber was conceived, as well as the first chair with a five star base on spinning wheels.

A dynamic backrest set new standards, which is used on the international level today.

Swivel chairs with a synchro ùnized mechanism and up-down devices are today's most comfortable and safest in the world.

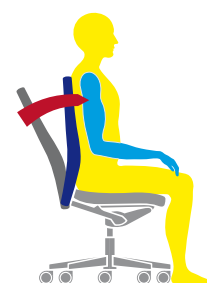

La regolazione della resistenza dello schienale

Grazie alla regolazione della reazione elastica, questo meccanismo consente di regolare la resistenza dello schienale in base alle preferenze personali di seduta di ciascun utilizzatore.

The regulation of the backrest resistance

Thanks to the regulation of the elastic reaction, this mechanism allows for the regulation of the backrest resistance according to personal preferences of each chair user.

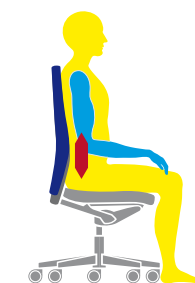

Lo schienale regolabile in altezza

L'altezza dello schienale può essere regolata su misura in base alla corporatura di ciascun utilizzatore e garantisce il posizionamento ottimale della curva dello schienale per il sostegno lombare.

Backrest regulation in height

The height of the backrest can be regulated according to the user's body and guarantees for an optimal positioning of the curve of the backrest for the lumbar support.

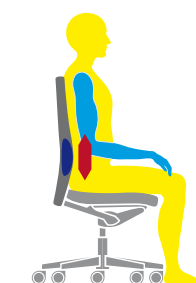

Il sostegno lombare regolabile in altezza

La regolazione dello schienale in altezza automaticamente, avendo il sostegno lombare integrato, garantisce in ogni momento un sostegno personalizzato della regione lombare.

Lumbar support height regulation

The automatic height regulation of the backrest which has an integrated lumbar support guarantees a personalized support of the lumbar region in all moments.



Il sedile anatomico

La forma anatomica del sedile garantisce il mantenimento della postura seduta corretta e dinamica, evitando l'involontario scivolamento in avanti del corpo.

The chair contour

The anatomical shape of the seat guarantees the maintainment of the correct dynamic posture to avoid the involuntary "forward sliding" of the body.



Il meccanismo

Il meccanismo è il primo elemento che garantisce il massimo comfort di seduta. Le molle meccaniche regolate in modo ottimale offrono una ripartizione dei carichi estremamente bilanciata durante la seduta dinamica. Il sedile e lo schienale si muovono in assoluta sincronia con il corpo.

The mechanism

The mechanism is the first element that guarantees maximum comfort for a chair. The mechanical springs are regulated in an optimal manner allowing for a balanced distribution of the weight as the chair moves dynamically. The seat and backrest move in absolute synchronicity with the body.

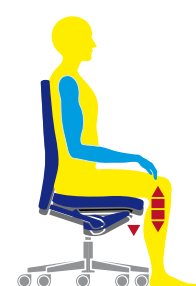

La regolazione in altezza

Un meccanismo estremamente duraturo e regolabile in altezza, che si adatta perfettamente anche a frequenti cambiamenti di utilizzatore. L'ammortizzazione del piano di seduta garantisce un leggero molleggio anche nella posizione più bassa.

Height regulation

An extremely durable mechanism that is adjustable in height, which is perfectly adaptable for frequent changes of the user. The cushioning of the seat surface guarantees a light springing even in the lowest position.

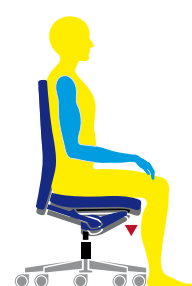

Le molle di ammortizzazione

Questo dispositivo elastico garantisce un'adeguata ammortizzazione della seduta grazie a una molla centrale, che offre un sostegno totale anche nella posizione di seduta più bassa e permette di evitare compressioni della colonna vertebrale.

The cushioning springs

This flexible device guarantees an adequate cushioning of the chair due to a central spring which offers a total support even in the lowest seating position and does not allow for the vertebral column to compress.

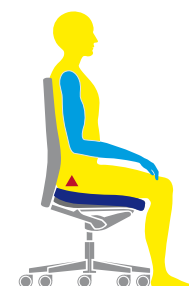

La regolazione dell'inclinazione del sedile

Il meccanismo di regolazione dell'inclinazione consente di variare di 4 gradi la posizione base del sedile, in modo tale da ottenere una superficie di seduta inclinata in avanti.

The regulation of the seat inclination

The mechanism for the inclination regulation allows for a 4 degree diversification of the base position of the seat in order to obtain a forward inclination of the seat surface.

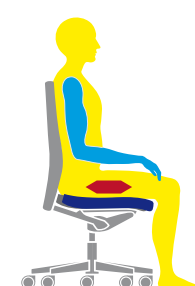

Sedile a scorrimento

Grazie allo scorrimento in avanti o indietro dell'imbottitura del sedile, è possibile modificare a proprio piacimento la base di appoggio della coscia.

Sliding seat

The forward and backward movements of the padded seat make it possible to change the surface support of the thighs.

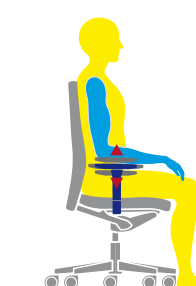

I braccioli regolabili

Questo meccanismo consente di regolare i braccioli in modo assolutamente personalizzato in base all'utilizzatore e all'attività svolta. Alcuni braccioli sono regolabili sia in altezza sia in larghezza sia in profondità.

Adjustable armrests

This mechanism allows for the regulation of the armrests in a personalized manner for the user according to the activity carried out. Some armrests are adjustable in height, in width and in depth.

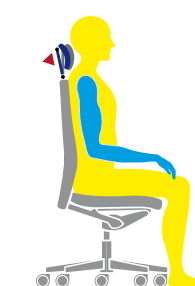

Poggiatesta regolabile

Per rilassare la muscolatura della nuca, molte sedute girevoli sono dotate di poggiatesta regolabili in altezza e inclinazione.

Adjustable headrest

Many swivel chairs provide a headrest adjustable in height and inclination in order to relax the nape muscles.

SEDIAKREATIVE

COLLECTION

EXECUTIVECHAIR

- 12 Prima
- 20 Start
- 28 Load
- 36 Rombo
- 44 Power
- 52 Sky
- 60 Sweet
- 68 Tela
- 76 Genio
- 84 Bays
- 96 Connect

WAITINGCHAIR

- 106 Tender
- 113 Hand
- 119 Comfort
- 123 Agree
- 129 Tetris
- 135 Formal
- 139 Travel
- 145 Point
- 153 Igloo
- 159 View
- 165 Corner

COMMUNITYCHAIR

- 172 Flex
- 178 Fly
- 186 Flag
- 196 Crono
- 206 Step
- 224 Target
- 236 Concordia
- 250 Tavoli



A close-up photograph of a blue leather chair. A prominent silver metal ring is visible, curving across the top of the chair's backrest. The leather has a fine, pebbled texture. The lighting is soft, highlighting the contours of the chair and the metallic sheen of the ring.

+ PRIMA

PRIMA



P04

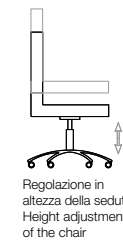

Regolazione in altezza della seduta
Height adjustment of the chair

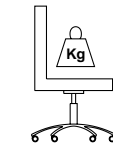

Regolazione della tensione in funzione al peso
Tension adjustment according to weight

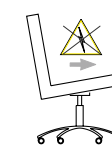

Anti-shock

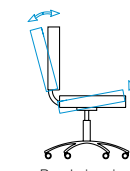

Regolazione in sincronia del sedile e dello schienale
Synchronized seat and backrest adjustment



La serie Prima in versione nero con braccioli in alluminio.

The Prima series in a black version with aluminium armrests.



P04



P08



PRIMA

La serie Prima rispetta l'attesa del suo nome, una seduta sicuramente al top della class.

The Prima series name lives up to its expectations, it is surely a top class chair.



P06



P02



PRIMA

1. Base a 5 razze in alluminio pressofuso spazzolato e lucidato.
2. Ruote piroettanti a doppia battitura gommata diametro 65 mm.
3. Alzo a gas tramite pompa a gas.
4. Movimenti:
 - piastra a gas (A) con leva per il comando della regolazione in altezza;
 - movimento sincronizzato (R) con 2 leve per blocco-sblocco in 5 posizioni con anti-shock, volantino per regolare la tensione dello schienale in base al peso.
5. Sedile con interno in acciaio rivestito.
6. Schienale con interno in acciaio.
7. Braccioli in alluminio.
8. Imbottiture in poliuretano schiumato a freddo.
9. Rivestimenti in base ns. cartella colori o tessuto cliente.
10. Norme di riferimento:
 - poltrone girevoli ed elevabili En 1335;
 - normative Uni vigenti.

1. Five star base in polished die cast aluminium.
2. Wheel castors twin rubber diameter 65 mm.
3. Gas lift.
4. Movements:
 - gas plate (A) with lever to regulate chair height.
 - synchronized movement (R) with 2 levers for block-unblock in 5 working positions with anti-shock and pommel for tension regulation of the backrest according to weight.
5. Seat made of steel.
6. Backrest inner part made of steel.
7. Armrests in aluminium.
8. Inner Upholstery in cold foamed polyurethane.
9. Covering according to our fabric colour chart or by customer's fabrics.
10. Reference regulation
 - En 1335 swivel and lift chair;
 - Uni regulations.



P02

P06



P04

P08



Bracciolo in alluminio
Aluminium armrest



NOVITÀ - NEW

Personalizzazione cliente
Customer personalization



Possibilità di avere le cuciture di colore diverso dal rivestimento.
Possibility to have different seam colour compared to upholstery

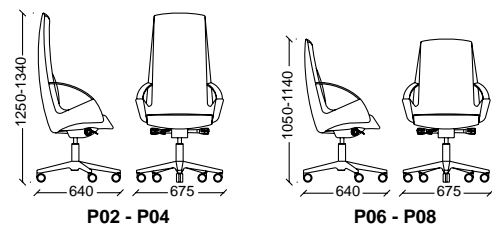

ABBINAMENTI / COMBINATIONS

Il trittico tradizionale è quello che è composto da prodotti coordinati della stessa serie, ma non deve essere una regola. La Seipo srl propone alcuni abbinamenti contemporanei per arredare il proprio ufficio al meglio. Naturalmente, le possibili combinazioni sono molteplici e di conseguenza gioca un ruolo non indifferente nel prezzo finale complessivo. Adesso puoi davvero comporre il tuo trittico ideale tenendo conto di una vasta scelta di modelli, di finiture, di design e di prezzo su misura al proprio budget.

The traditional triptych of chairs is usually composed of coordinated products from the same series, this does not have to be a rule. Seipo srl suggests some contemporary combinations in order for you to furnish your office at its best. Naturally, the possible matchings are numerous and for this reason play a key role in determining the final price. Now you can really create your ideal set of chairs by considering a vast choice of models, finishes, designs and the right price to meet your budget.

	+		PRIMA
	+		IGLOO
	+		CORNER
	+		CORNER
	+		FLEX
	+		FLEX
	+		FLAG
	+		FLAG
	+		CRONO
	+		CRONO
	+		STEP
	+		STEP



+ START



START

I modelli della serie Start sono un vero esempio di eleganza, ergonomia e imponenza. La scelta di una start garantisce al cliente qualità e comfort.

The Start series models are a real example of elegance, ergonomics and impressiveness. The choice of a Start guarantees quality and comfort to the customer.



S73



S76



S70



START

La poltrona slitta a visitatore con schienale medio o basso evidenzia l'importanza di questa serie.

The cantilever visitor chair, with medium or low backrest, underlines the importance of this series.



S77



S78



S79



S82



S85



S87



S89

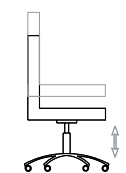

Regolazione in altezza della seduta
Height adjustment of the chair

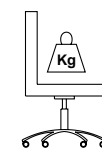

Regolazione della tensione in funzione al peso
Tension adjustment according to weight

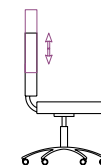

Regolazione in altezza dello schienale
Backrest height adjustment

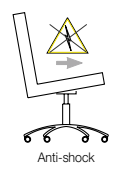

Anti-shock

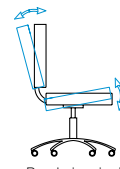

Regolazione in sincronia del sedile e dello schienale
Synchronized seat and backrest adjustment

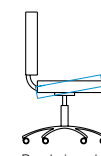

Regolazione del sedile in inclinazione
Seat inclination adjustment



START

1. Base a 5 razze in alluminio pressofuso spazzolato e lucidato.
2. Ruote piroettanti a doppia battitura gommata diametro 65 mm.
3. Alzo a gas tramite pompa a gas.
4. Movimenti:
 - piastra a gas (A) con leva per il comando della regolazione in altezza;
 - movimento sincronizzato (R) con 2 leve per blocco-sblocco in 5 posizioni con antishock, volantino per regolare la tensione dello schienale in base al peso, regolazione in altezza dello schienale tramite sistema up-down;
 - movimento asincrono (Q) con 3 leve per blocco-sblocco dello schienale in 4 posizioni con anti-shock, manopola per regolare la tensione dello schienale in base al peso, regolazione in altezza dello schienale tramite sistema up-down;
 - opzionale traslatore (TR) per la regolazione del sedile in profondità che consente 5 posizioni di blocco tramite pulsante posto sotto il sedile.
5. Sedile con interno in acciaio.
6. Schienale con interno in acciaio ricoperto in nylon.
7. Braccioli:
 - con interno in acciaio schiumato a freddo e rivestito;
 - in acciaio cromato con pad rivestito.
8. Poltrone fisse:
 - visitatore a slitta in acciaio cromato con schienale medio e braccioli incorporati con pad in nylon nero;
 - visitatore a slitta in acciaio cromato con schienale basso e braccioli incorporati con pad in nylon nero.
9. Imbottiture in resine poliuretatiche ignifughe classe 11M e dacron.
10. Rivestimenti in base ns. cartella colori o tessuto cliente.
11. Norme di riferimento
 - poltrone girevoli ed elevabili En 1335;
 - poltrone non regolabili in altezza En 13761;
 - normative Uni vigenti;
 - solo a richiesta omologazione classe 11M con tessuto Categoria L con sovrapprezzo del 10%.

1. Five star base in polished die cast aluminium.
2. Wheel castors twin rubber diameter 65 mm.
3. Gas lift.
4. Movements:
 - gas plate (A) with lever to regulate chair height;
 - synchronized movement (R) with 2 levers for block-unblock in 5 working positions with anti-shock and pommel for tension regulation of the backrest according to weight and up-down system for backrest height adjustment;
 - synchronized "point effect" movement (Q) with 3 levers for block-unblock of backrest in 4 working positions with anti-shock, pommel for tension regulation of the backrest according to weight, seat adjustment in all inclined positions, height adjustable backrest with up-down system;
 - optional seat slider (TR) for depth adjustment of the seat in 5 blocking positions with under seat push button.
5. Seat made of steel.
6. Backrest inner part made of steel with nylon cover.
7. Armrests:
 - made of steel, cold foamed and upholstered;
 - in chromed steel with upholstered pad.
8. Visitor chairs:
 - chromed steel cantilever chair with medium backrest, incorporated armrests and black nylon pad;
 - chromed steel cantilever chair with low backrest, incorporated armrests and black nylon pad.
9. Inner Upholstery in expanded flame retardant polyurethane class 11M and dacron.
10. Covering according to our fabric colour chart or by customer's fabrics.
11. Reference regulation
 - En 1335 swivel and lift chair;
 - En 13761 visitor chair;
 - Uni regulations;
 - Only on approval request, 11M class with category L fabric cost an extra 10%.



NOVITÀ - NEW
Personalizzazione cliente
Customer personalization

Possibilità di avere le cuciture di colore diverso dal rivestimento
Possibility to have many kinds

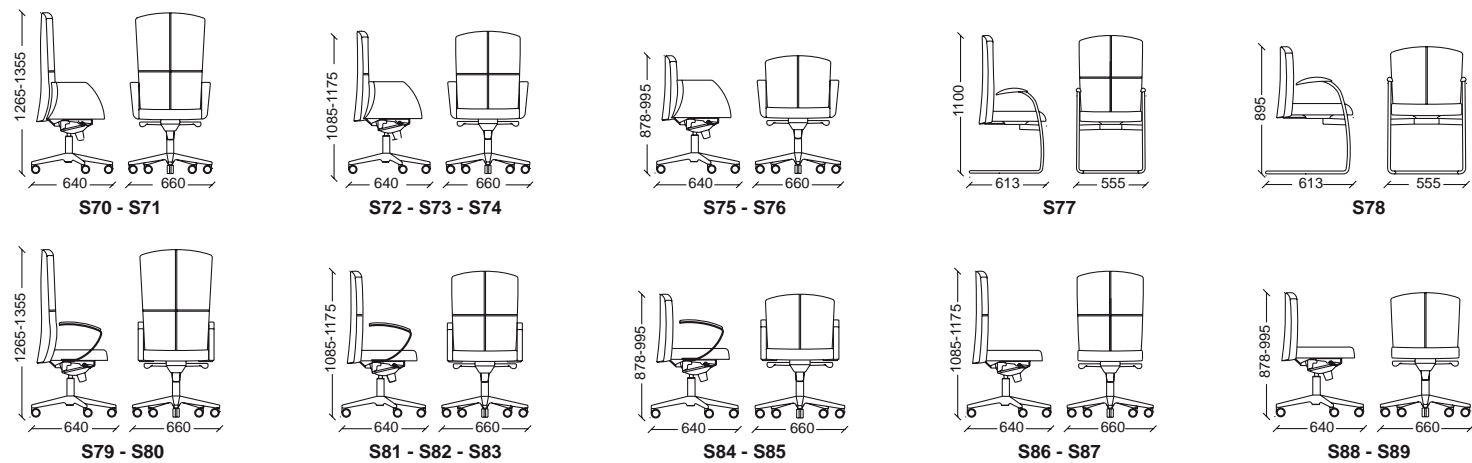

ABBINAMENTI / COMBINATIONS

Il tritico tradizionale è quello che è composto da prodotti coordinati della stessa serie, ma non deve essere una regola. La Seipo srl propone alcuni abbinamenti contemporanei per arredare il proprio ufficio al meglio. Naturalmente, le possibili combinazioni sono molteplici e di conseguenza gioca un ruolo non indifferente nel prezzo finale complessivo. Adesso puoi davvero comporre il tuo tritico ideale tenendo conto di una vasta scelta di modelli, di finiture, di design e di prezzo su misura al proprio budget.

The traditional triptych of chairs is usually composed of coordinated products from the same series, this does not have to be a rule. Seipo srl suggests some contemporary combinations in order for you to furnish your office at its best. Naturally, the possible matchings are numerous and for this reason play a key role in determining the final price. Now you can really create your ideal set of chairs by considering a vast choice of models, finishes, designs and the right price to meet your budget.

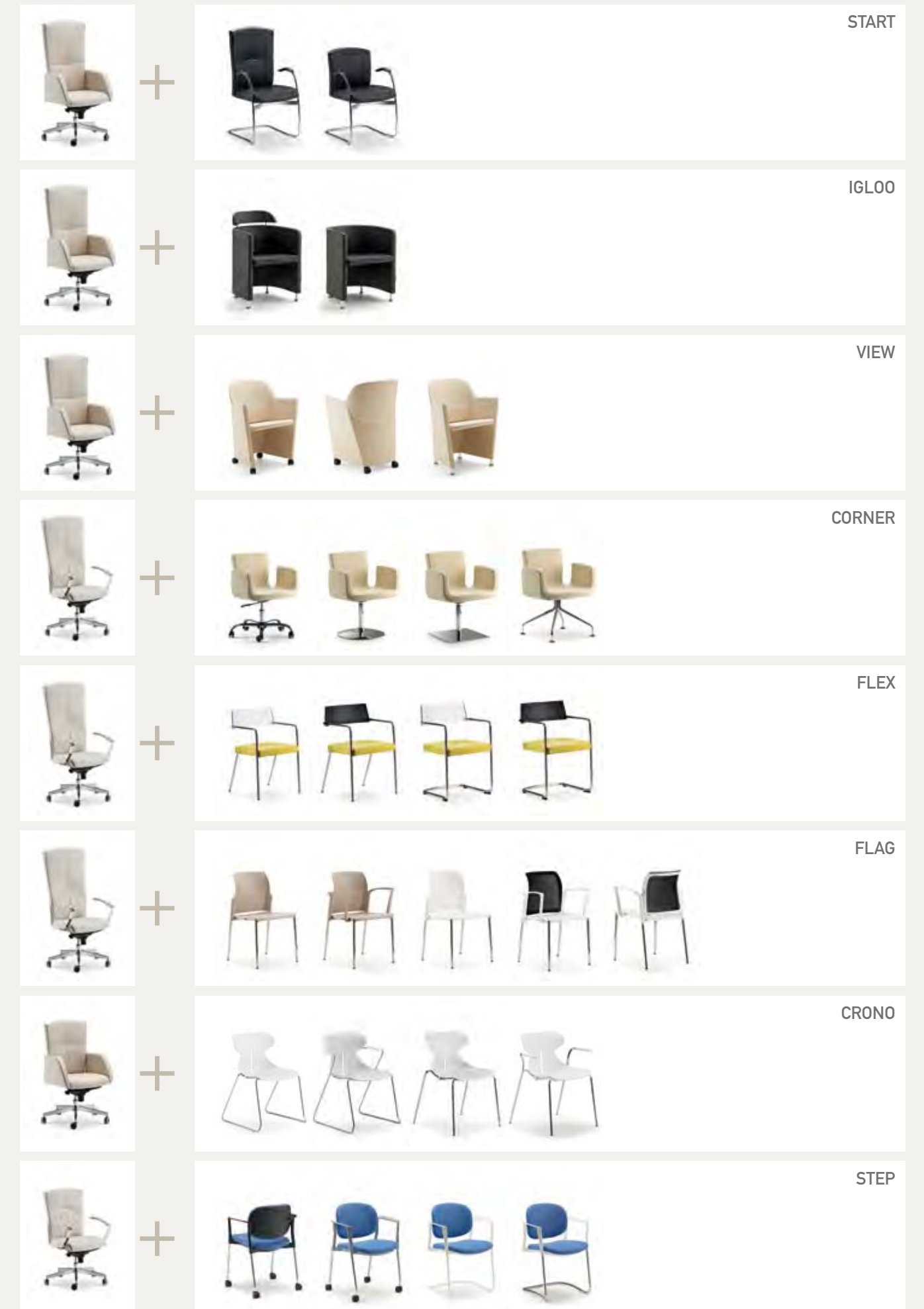

A close-up photograph of a blue leather bag with a black strap. The bag is made of a textured blue leather and features a black strap with a gold-colored metal buckle. The lighting is dramatic, highlighting the texture of the leather and the sleek lines of the strap. The background is a plain, light color.

+ LOAD



L62



L62



L67



L70



L73



L76



L80

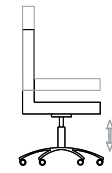

Regolazione in altezza della seduta
Height adjustment of the chair



Oscillazione libera della poltrona e blocco nella posizione di lavoro
Free tilting movement of the chair and blocking in the working position

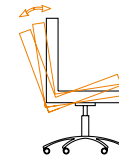

Regolazione in inclinazione della poltrona e blocco in più posizioni
Inclination adjustment of the chair and blocking in various positions

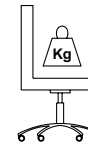

Regolazione della tensione in funzione al peso
Tension adjustment according to weight



Anti-shock

LOAD

La serie Load mostra un design innovativo e comodo correlato ad una vasta gamma di poltrone ideale per comporre un trittico.

The Load series emphasizes an innovative and comfortable design correlated by a vast selection of visitor chairs for the composition of an ideal triptych.



L72



L75



L85



L88



L90

LOAD

1. Base a 5 razze in alluminio pressofuso spazzolato e lucidato.
2. Ruote piroettanti a doppia battitura gommata diametro 65 mm.
3. Alzo a gas tramite pompa a gas.
4. Movimenti:
 - piastra a gas (A) con leva per il comando della regolazione in altezza;
 - movimento oscillante (B) con blocco nella posizione di lavoro, volantino per regolare la tensione dello schienale in funzione al peso;
 - movimento oscillante multi block (C) con comando monoleva, bloccaggio in 5 posizioni con anti-shock, volantino per regolare la tensione dello schienale in funzione al peso;
 - movimento con punto di rotazione avanzato (D) a 2 leve con comando a rotazione per blocco-sblocco con anti-shock in 3 posizioni, volantino per regolare la tensione dello schienale in funzione al peso.
5. Monoscocca interna in multistrato di faggio e pino curvato spessore 12 mm con contro scocca.
6. Braccioli:
 - in acciaio cromato con pad rivestito;
 - in poliuretano con inserto in acciaio.
7. Poltrone fisse:
 - visitatore a slitta in acciaio cromato senza braccioli;
 - visitatore a slitta in acciaio cromato con braccioli in acciaio cromato e pad rivestito;
 - visitatore a slitta in acciaio cromato con braccioli in poliuretano con inserto in acciaio;
 - visitatore a 4 gambe in acciaio cromato conificata da diametro 30 mm a diametro 18 mm e dotate di piedini orientabili, senza braccioli;
 - visitatore a 4 gambe in acciaio cromato conificata da diametro 30 mm a diametro 18 mm e dotate di piedini orientabili con braccioli in acciaio cromato e pad rivestito;
 - visitatore a 4 gambe in acciaio cromato conificata da diametro 30 mm a diametro 18 mm e dotate di piedini orientabili con braccioli in poliuretano con inserto in acciaio.
8. Imbottiture in resine poliuretatiche ignifughe classe 1IM e dacron
9. Rivestimenti in base ns. cartella colori o tessuto cliente.
10. Norme di riferimento
 - poltrone girevoli ed elevabili En 1335;
 - poltrone non regolabili in altezza En 13761;
 - normative Uni vigenti;
 - solo a richiesta omologazione classe 1IM con tessuto Categoria L con sovrapprezzo del 10%.

1. Five star base in polished die cast aluminium.
2. Wheel castors twin rubber diameter 65 mm.
3. Gas lift.
4. Movements:
 - gas plate (A) with lever to regulate chair height;
 - oscillation movement (B) with work position block and pommel for tension regulation of the backrest according to weight;
 - oscillation movement multiblock (C) single lever with 5 blockable positions with anti-shock and pommel for tension regulation of the backrest according to weight;
 - movement with advanced rotation point (D) with 2 levers, turnable lever to block and unblock in 3 positions with anti-shock and pommel for tension regulation of the backrest according to weight.
5. Shell body made of curved beech and poplar wood in multiple layers thickness 12 mm with double shell body.
6. Armrests:
 - in chromed steel with upholstered pad;
 - in polyurethane with steel insert.
7. Visitor chairs:
 - chromed steel cantilever chair without armrests.
 - chromed steel cantilever chair with chromed steel armrests and upholstered pad.
 - chromed steel cantilever visitor chair with polyurethane armrests with steel insert.
 - chromed steel four leg chair with cone shaped legs diameter 30 mm to diameter 18 mm with adjustable feet, without armrests.
 - chromed steel four leg chair with cone shaped legs diameter 30 mm to diameter 18 mm with adjustable feet and chromed steel armrests with upholstered pad.
 - chromed steel four leg chair with cone shaped legs diameter 30 mm to diameter 18 mm with adjustable feet and polyurethane armrests with steel insert.
8. Inner Upholstery in expanded flame retardant polyurethane class 1IM and dacron.
9. Covering according to our fabric colour chart or by customer's fabrics.
10. Reference regulation
 - En 1335 swivel and lift chair;
 - En 13761 visitor chair;
 - Uni regulations;
 - Only on approval request, 1IM class with category L fabric cost an extra 10%.

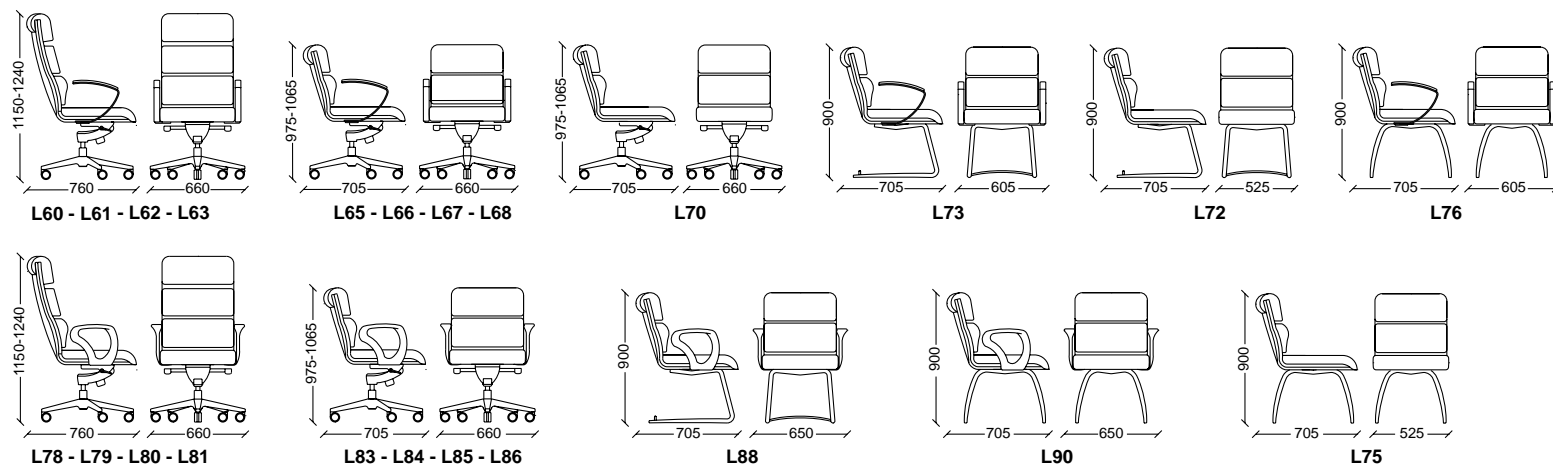

ABBINAMENTI / COMBINATIONS

Il trittico tradizionale è quello che è composto da prodotti coordinati della stessa serie, ma non deve essere una regola. La Seipo srl propone alcuni abbinamenti contemporanei per arredare il proprio ufficio al meglio. Naturalmente, le possibili combinazioni sono molteplici e di conseguenza gioca un ruolo non indifferente nel prezzo finale complessivo. Adesso puoi davvero comporre il tuo trittico ideale tenendo conto di una vasta scelta di modelli, di finiture, di design e di prezzo su misura al proprio budget.

The traditional triptych of chairs is usually composed of coordinated products from the same series, this does not have to be a rule. Seipo srl suggests some contemporary combinations in order for you to furnish your office at its best. Naturally, the possible matchings are numerous and for this reason play a key role in determining the final price. Now you can really create your ideal set of chairs by considering a vast choice of models, finishes, designs and the right price to meet your budget.

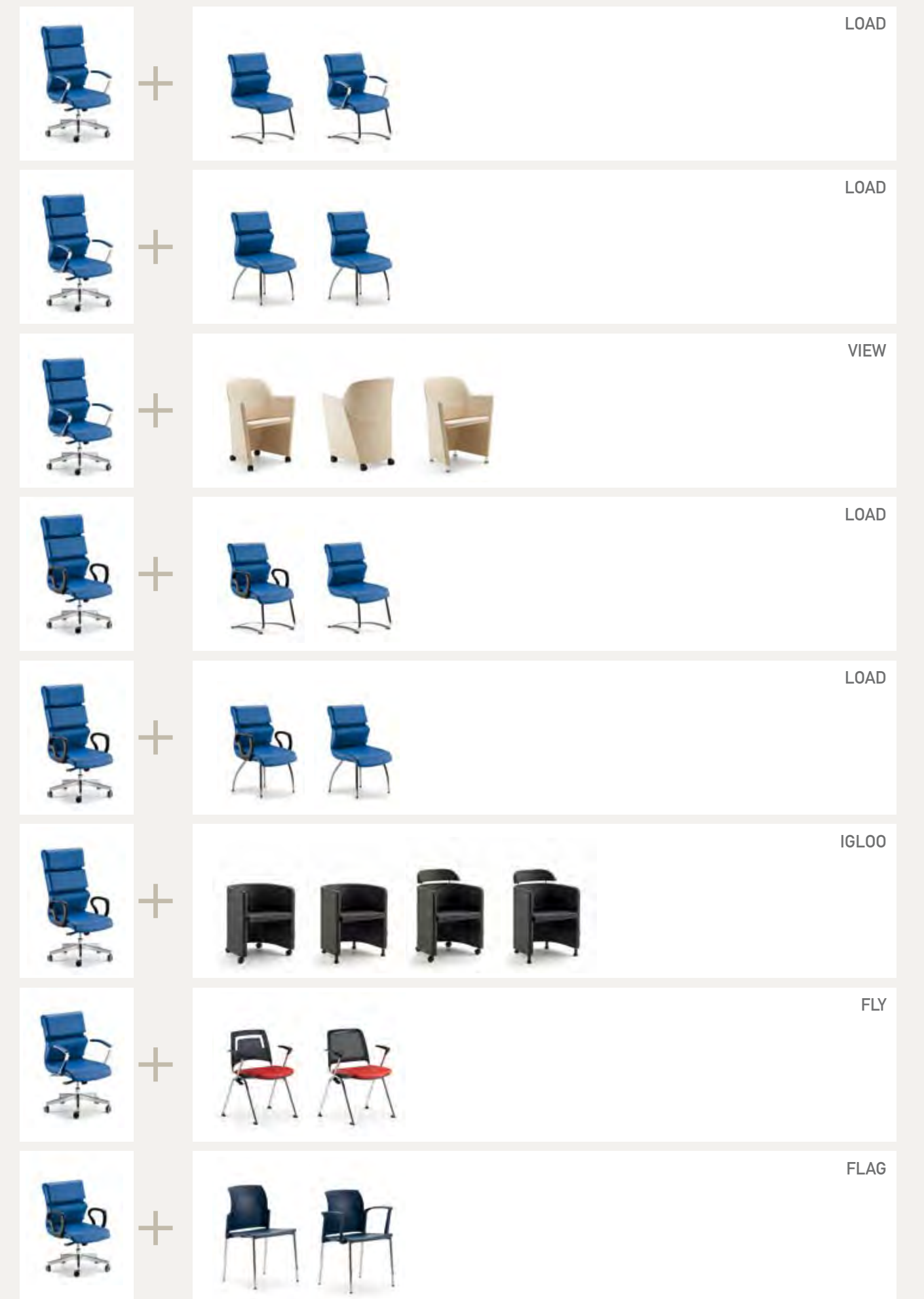



+ ROMBO



ROMBO

La serie Rombo si distingue per la sua vera identità artigianale che la rende un vero pezzo unico.

The Rombo series distinguishes itself for its authentic craftsmanship which makes it a rare specimen.



R08



R11



R13



R04



R15

ROMBO

La serie Rombo è disponibile con cucitura tradizionale.

The Rombo series is available with traditional stitching.

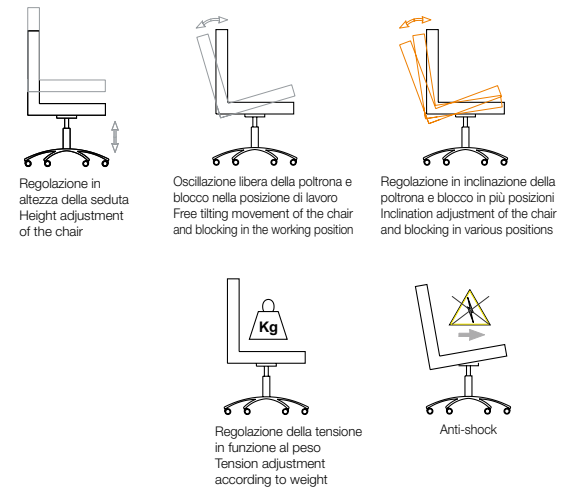

R30



R28

La serie Rombo mostra le sue deliziose poltrone visitatore.

The Rombo series offers lovely visitor chairs.



R19



R23



R26

ROMBO

1. Base a 5 razze in alluminio pressofuso spazzolato e lucidato.
2. Ruote piroettanti a doppia battitura gommata diametro 65 mm.
3. Alzo a gas tramite pompa a gas.
4. Movimenti:
 - piastra a gas (A) con leva per il comando della regolazione in altezza;
 - movimento oscillante (B) con blocco nella posizione di lavoro, volantino per regolare la tensione dello schienale in funzione al peso;
 - movimento oscillante multi block (C) con comando monoleva, bloccaggio in 5 posizioni con anti-shock, volantino per regolare la tensione dello schienale in funzione al peso;
 - movimento con punto di rotazione avanzato (D) a 2 leve con comando a rotazione per blocco-sblocco con anti-shock in 3 posizioni, volantino per regolare la tensione dello schienale in funzione al peso.
5. Telaio in acciaio cromato curvato.
6. Braccioli in alluminio rivestiti.
7. Poltrone fisse:
 - visitatore a slitta tubolare a sezione tonda diametro 25 mm in acciaio cromato senza braccioli;
 - visitatore a slitta tubolare a sezione tonda diametro 25 mm in acciaio cromato con braccioli in alluminio rivestiti.
8. Imbottiture in resine poliuretatiche ignifughe classe 11M.
9. Rivestimenti in base ns. cartella colori o tessuto cliente.
10. Norme di riferimento
 - poltrone girevoli ed elevabili En 1335;
 - poltrone non regolabili in altezza En 13761;
 - normative Uni vigenti;
 - solo a richiesta omologazione classe 11M con tessuto Categoria L con sovrapprezzo del 10%.

1. Five star base in polished die cast aluminium.
2. Wheel castors twin rubber diameter 65 mm.
3. Gas lift.
4. Movements:
 - gas plate (A) with lever to regulate chair height;
 - oscillation movement (B) with work position block and pommel for tension regulation of the backrest according to weight;
 - oscillation movement multiblock (C) single lever with 5 blockable positions with anti-shock and pommel for tension regulation of the backrest according to weight;
 - movement with advanced rotation point (D) with 2 levers, turnable lever to block and unblock in 3 positions with anti-shock and pommel for tension regulation of the backrest according to weight.
5. Frame chromed steel body.
6. Armrests in aluminium with upholstered pad.
7. Visitor chairs:
 - chromed steel tubular cantilever round frame diameter 25 mm without armrests;
 - chromed steel tubular cantilever round frame diameter 25 mm with aluminium armrests with upholstered pad.
8. Inner Upholstery in expanded flame retardant polyurethane class 11M
9. Covering according to our fabric colour chart or by customer's fabrics.
10. Reference regulation
 - En 1335 swivel and lift chair;
 - En 13761 visitor chair;
 - Uni regulations;
 - Only on approval request, 11M class with category L fabric cost an extra 10%.

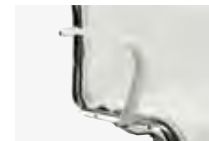

Braccioli in alluminio rivestito
Upholstered aluminium armrest



Base in alluminio
Aluminium base



NOVITÀ - NEW

Personalizzazione cliente
Customer personalization

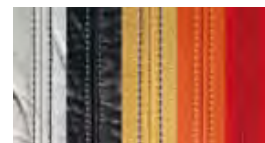

Possibilità di avere le cuciture di colore diverso dal rivestimento
Possibility to have different seam colour compared to upholstery

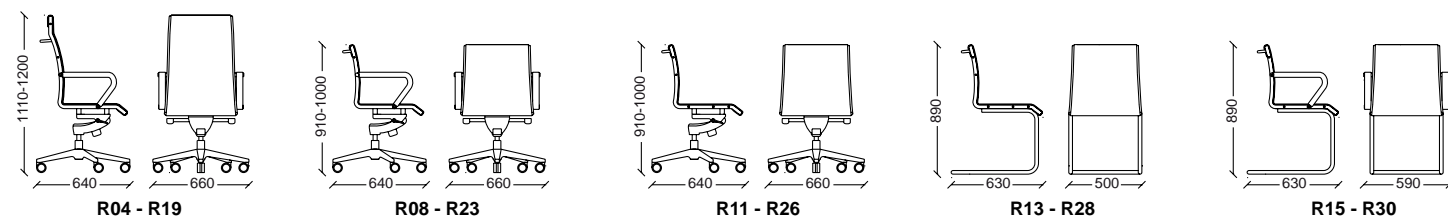

ABBINAMENTI / COMBINATIONS

Il trittico tradizionale è quello che è composto da prodotti coordinati della stessa serie, ma non deve essere una regola. La Seipo srl propone alcuni abbinamenti contemporanei per arredare il proprio ufficio al meglio. Naturalmente, le possibili combinazioni sono molteplici e di conseguenza gioca un ruolo non indifferente nel prezzo finale complessivo. Adesso puoi davvero comporre il tuo trittico ideale tenendo conto di una vasta scelta di modelli, di finiture, di design e di prezzo su misura al proprio budget.

The traditional triptych of chairs is usually composed of coordinated products from the same series, this does not have to be a rule. Seipo srl suggests some contemporary combinations in order for you to furnish your office at its best. Naturally, the possible matchings are numerous and for this reason play a key role in determining the final price. Now you can really create your ideal set of chairs by considering a vast choice of models, finishes, designs and the right price to meet your budget.

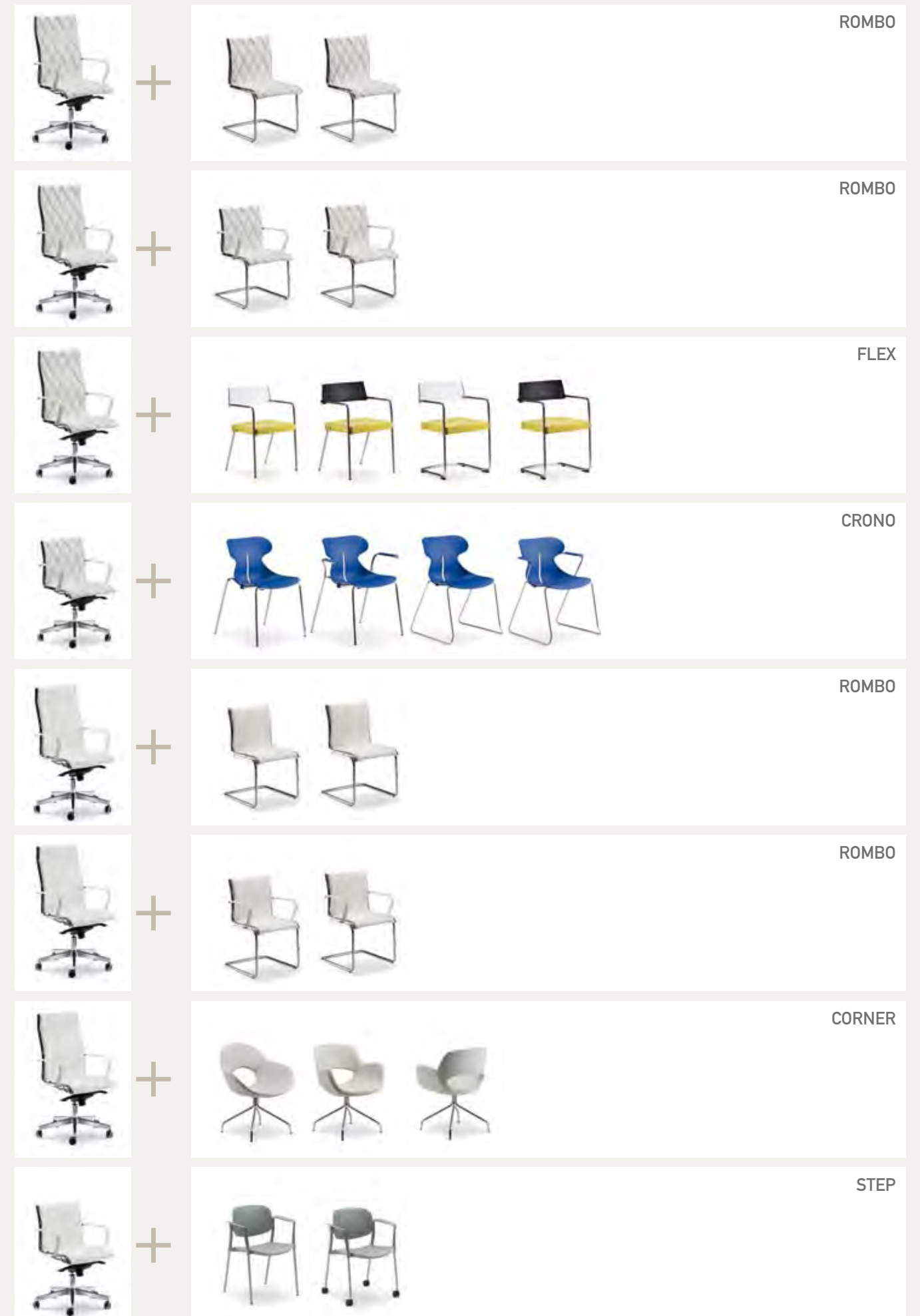

A close-up photograph of a blue leather bag. The bag features a prominent diagonal seam and a metal clasp mechanism. The leather has a fine, pebbled texture. The lighting is soft, highlighting the contours and the texture of the material. The background is a plain, light color.

+ POWER

POWER



P52

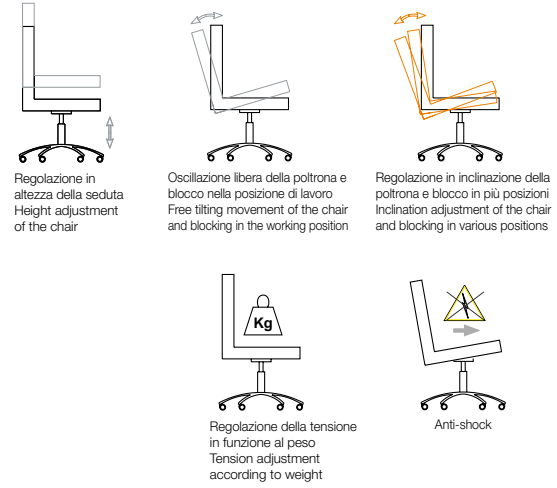

P52



P57



P63



P66



POWER

La serie Power mostra un look lineare con poggiatesta incorporata in tutti i suoi modelli per assicurare una posizione di lavoro confortevole.

The Power series expresses a linear look with an incorporated headrest in all of its models and assures for a pleasant working position.



P62



P65



P70



P75



P60



P77



P79

POWER

1. Base a 5 razze in alluminio pressofuso spazzolato e lucidato.
2. Ruote piroettanti a doppia battitura gommata diametro 65 mm.
3. Alzo a gas tramite pompa a gas.
4. Movimenti:
 - piastra a gas (A) con leva per il comando della regolazione in altezza;
 - movimento oscillante (B) con blocco nella posizione di lavoro, volantino per regolare la tensione dello schienale in funzione al peso;
 - movimento oscillante multi block (C) con comando monoleva, bloccaggio in 5 posizioni con anti-shock, volantino per regolare la tensione dello schienale in funzione al peso;
 - movimento con punto di rotazione avanzato (D) a 2 leve con comando a rotazione per blocco-sblocco con anti-shock in 3 posizioni, volantino per regolare la tensione dello schienale in funzione al peso.
5. Monoscocca interna in multistrato di faggio e pino curvato spessore 12 mm con contro scocca.
6. Braccioli:
 - in acciaio cromato con pad rivestito;
 - in poliuretano con inserto in acciaio.
7. Poltrone fisse:
 - visitatore a slitta in acciaio cromato senza braccioli;
 - visitatore a slitta in acciaio cromato con braccioli in acciaio cromato e pad rivestito;
 - visitatore a slitta in acciaio cromato con braccioli in poliuretano con inserto in acciaio;
 - visitatore a 4 gambe in acciaio cromato conificata da diametro 30 mm a diametro 18 mm e dotate di piedini orientabili, senza braccioli;
 - visitatore a 4 gambe in acciaio cromato conificata da diametro 30 mm a diametro 18 mm e dotate di piedini orientabili con braccioli in acciacromato e pad rivestito;
 - visitatore a 4 gambe in acciaio cromato conificata da diametro 30 mm a diametro 18 mm e dotate di piedini orientabili con braccioli in poliuretano con inserto in acciaio.
8. Imbottiture in resine poliuretaniche ignifughe classe 1IM.
9. Rivestimenti in base ns. cartella colori o tessuto cliente.
10. Norme di riferimento
 - poltrone girevoli ed elevabili En 1335;
 - poltrone non regolabili in altezza En 13761;
 - normative Uni vigenti;
 - solo a richiesta omologazione classe 1IM con tessuto Categoria L con sovrapprezzo del 10%.

1. Five star base in polished die cast aluminium.
2. Wheel castors twin rubber diameter 65 mm.
3. Gas lift.
4. Movements:
 - gas plate (A) with lever to regulate chair height;
 - oscillation movement (B) with work position block and pommel for tension regulation of the backrest according to weight;
 - oscillation movement multiblock (C) single lever with 5 blockable positions with anti-shock and pommel for tension regulation of the backrest according to weight;
 - movement with advanced rotation point (D) with 2 levers, turnable lever to block and unblock in 3 positions with anti-shock and pommel for tension regulation of the backrest according to weight.
5. Shell body made of curved beech and poplar wood in multiple layers thickness 12 mm with double shell body.
6. Armrests:
 - in chromed steel with upholstered pad;
 - in polyurethane with steel insert.
7. Visitor chairs:
 - chromed steel cantilever chair without armrests;
 - chromed steel cantilever chair with chromed steel armrests and upholstered pad;
 - chromed steel cantilever visitor chair with polyurethane armrests with steel insert;
 - chromed steel four leg chair with cone shaped legs diameter 30 mm to diameter 18 mm with adjustable feet, without armrests.
 - chromed steel four leg chair with cone shaped legs diameter 30 mm to diameter 18 mm with adjustable feet and chromed steel armrests with upholstered pad;
 - chromed steel four leg chair with cone shaped legs diameter 30 mm to diameter 18 mm with adjustable feet and polyurethane armrests with steel insert.
8. Inner Upholstery in expanded flame retardant polyurethane class 1IM
9. Covering according to our fabric colour chart or by customer's fabrics.
10. Reference regulation
 - En 1335 swivel and lift chair;
 - En 13761 visitor chair;
 - Uni regulations;
 - Only on approval request, 1IM class with category L fabric cost an extra 10%.

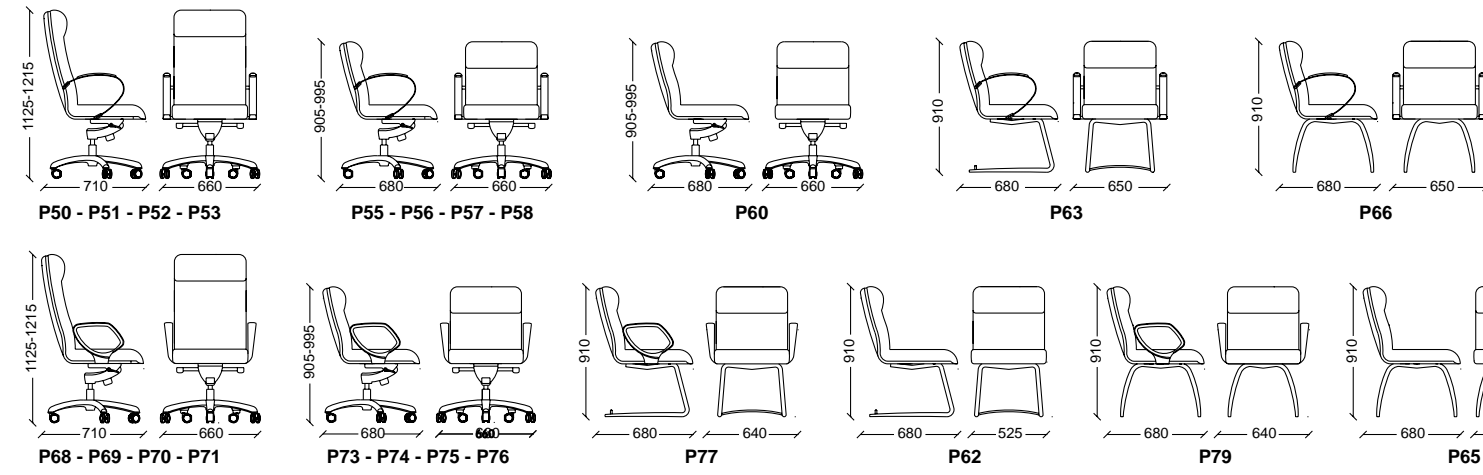

ABBINAMENTI / COMBINATIONS

Il tritico tradizionale è quello che è composto da prodotti coordinati della stessa serie, ma non deve essere una regola. La Seipo srl propone alcuni abbinamenti contemporanei per arredare il proprio ufficio al meglio. Naturalmente, le possibili combinazioni sono molteplici e di conseguenza gioca un ruolo non indifferente nel prezzo finale complessivo. Adesso puoi davvero comporre il tuo tritico ideale tenendo conto di una vasta scelta di modelli, di finiture, di design e di prezzo su misura al proprio budget.

The traditional triptych of chairs is usually composed of coordinated products from the same series, this does not have to be a rule. Seipo srl suggests some contemporary combinations in order for you to furnish your office at its best. Naturally, the possible matchings are numerous and for this reason play a key role in determining the final price. Now you can really create your ideal set of chairs by considering a vast choice of models, finishes, designs and the right price to meet your budget.

	+		POWER
	+		POWER
	+		CORNER
	+		POWER
	+		POWER
	+		FLEX
	+		STEP
	+		FLY

+ SKY



SK40

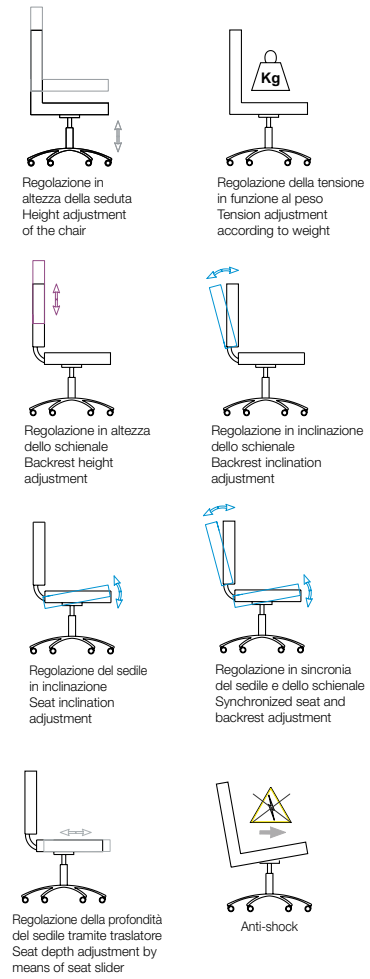

SK40



SK43



SK46



SK48

SKY

La serie Sky è disponibile in versione cromata o nera con schienali di varie altezze e dispone di una vasta gamma di movimenti a scelta.

The Sky series is available in chromed or black versions with various height size backrests and allows for a numerous choice of movement mechanisms.



SK49



SK50



SK51



SK40





SKY



SK62



SK53



SK56



SK59



SK61



SK63



SK64

SKY

1. Base a 5 razze:
 - in alluminio pressofuso spazzolato e lucidato;
 - in nylon nero caricato con fibre di vetro.
2. Ruote piroettanti a doppia battitura gommata diametro 50 mm.
3. Alzo a gas tramite pompa a gas.
4. Movimenti:
 - piastra a gas (A) con leva per il comando della regolazione in altezza;
 - movimento sincronizzato (R) con 2 leve per blocco-sblocco in 5 posizioni con anti-shock, volantino per regolare la tensione dello schienale in base al peso, regolazione in altezza dello schienale tramite sistema up-down;
 - Movimento asincrono (Q) con 3 leve per blocco-sblocco dello schienale in 4 posizioni con anti-shock, manopola per regolare la tensione dello schienale in base al peso, regolazione del sedile in tutte le posizioni d'inclinazione, regolazione in altezza dello schienale tramite sistema up-down;
 - opzionale traslatore (TR) per la regolazione del sedile in profondità che consente 5 posizioni di blocco tramite pulsante posto sotto il sedile.
5. Sedile in multistrato di faggio e pino curvato spessore 12 mm.
6. Schienale con interno in materiale composito stampato ricoperto in nylon.
7. Braccioli in poliuretano con staffa in acciaio cromato regolabili in altezza, profondità, orientabili e regolabili in larghezza.
8. Poltrone fisse:
 - visitatore a slitta tubolare a sezione quadra 20x20 mm in acciaio verniciato nero o cromato senza braccioli;
 - visitatore a slitta tubolare a sezione quadra 20x20 mm in acciaio verniciato nero o cromato con braccioli incorporati e pad in poliuretano;
 - visitatore a 4 gambe tubolare a sezione ovale 30x15 mm in acciaio verniciato nero o cromato con braccioli incorporati.
9. Imbottiture in resine poliuretane ignifughe classe 11M.
10. Rivestimenti in base ns. cartella colori o tessuto cliente.
11. Norme di riferimento
 - poltrone girevoli ed elevabili En 1335
 - poltrone non regolabili in altezza En 13761
 - normative Uni vigenti
 - solo a richiesta omologazione classe 11M con tessuto Categoria L con sovrapprezzo del 10%.

1. Five star base:
 - in polished die cast aluminium.
 - in black nylon with reinforced fibre glass.
2. Wheel castors twin rubber diameter 50 mm.
3. Gas lift.
4. Movements:
 - gas plate (A) with lever to regulate chair height;
 - synchronized movement (R) with 2 levers for block-unblock in 5 working positions with anti-shock and pommel for tension regulation of the backrest according to weight and up-down system for backrest height adjustment;
 - synchronized "point effect" movement (Q) with 3 levers for block-unblock of backrest in 4 working positions with anti-shock, pommel for tension regulation of the backrest according to weight, seat adjustment in all inclined positions, height adjustable backrest with up-down system;
 - optional seat slider (TR) for depth adjustment of the seat in 5 blocking positions with under seat push button.
5. Seat made of curved beech and poplar wood in multiple layers thickness 12 mm.
6. Backrest made of moulded mixed materials with nylon cover.
7. Armrests in black nylon with polyurethane pad, chromed steel support, adjustable in height, depth, inward and outward movement and in width.
8. Visitor chairs:
 - chromed steel or black varnished steel cantilever squared frame 20x20 mm without armrests;
 - chromed steel or black varnished steel cantilever squared frame 20x20 mm with incorporated armrests and polyurethane pad;
 - chromed steel or black varnished steel 4 leg oval frame 30x15 mm with incorporated armrests.
9. Inner Upholstery in expanded flame retardant polyurethane class 11M
10. Covering according to our fabric colour chart or by customer's fabrics.
11. Reference regulation
 - En 1335 swivel and lift chair;
 - En 13761 visitor chair;
 - Uni regulations;
 - Only on approval request, 11M class with category L fabric cost an extra 10%.

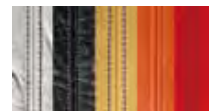

Possibilità di avere le cuciture di colore diverso dal rivestimento
Possibility to have different seam colour compared to upholstery



NOVITÀ - NEW
Personalizzazione cliente
Customer personalization

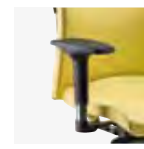

Bracciolo regolabile
Adjustable armrest

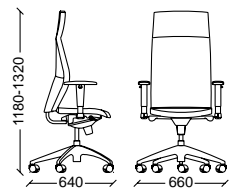

SK52 - SK53 - SK54
SK39 - SK40 - SK41

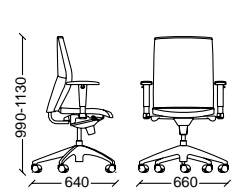

SK55 - SK56 - SK57
SK42 - SK43 - SK44

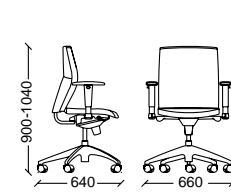

SK58 - SK59
SK45 - SK46

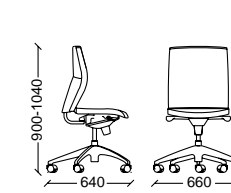

SK60 - SK61
SK47 - SK48

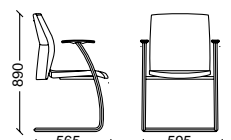

SK62 - SK49

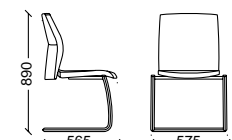

SK63 - SK50



SK64 - SK51

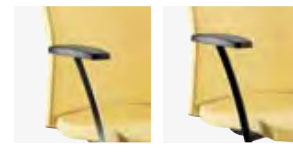

Bracciolo per telaio slitta
Cantilever visitor chair armrest

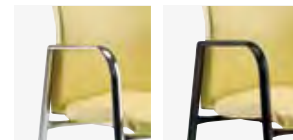

Bracciolo telaio 4 gambe
4 leg chair armrest

ABBINAMENTI / COMBINATIONS

Il trittico tradizionale è quello che è composto da prodotti coordinati della stessa serie, ma non deve essere una regola. La Seipo srl propone alcuni abbinamenti contemporanei per arredare il proprio ufficio al meglio. Naturalmente, le possibili combinazioni sono molteplici e di conseguenza gioca un ruolo non indifferente nel prezzo finale complessivo. Adesso puoi davvero comporre il tuo trittico ideale tenendo conto di una vasta scelta di modelli, di finiture, di design e di prezzo su misura al proprio budget.

The traditional triptych of chairs is usually composed of coordinated products from the same series, this does not have to be a rule. Seipo srl suggests some contemporary combinations in order for you to furnish your office at its best. Naturally, the possible matchings are numerous and for this reason play a key role in determining the final price. Now you can really create your ideal set of chairs by considering a vast choice of models, finishes, designs and the right price to meet your budget.

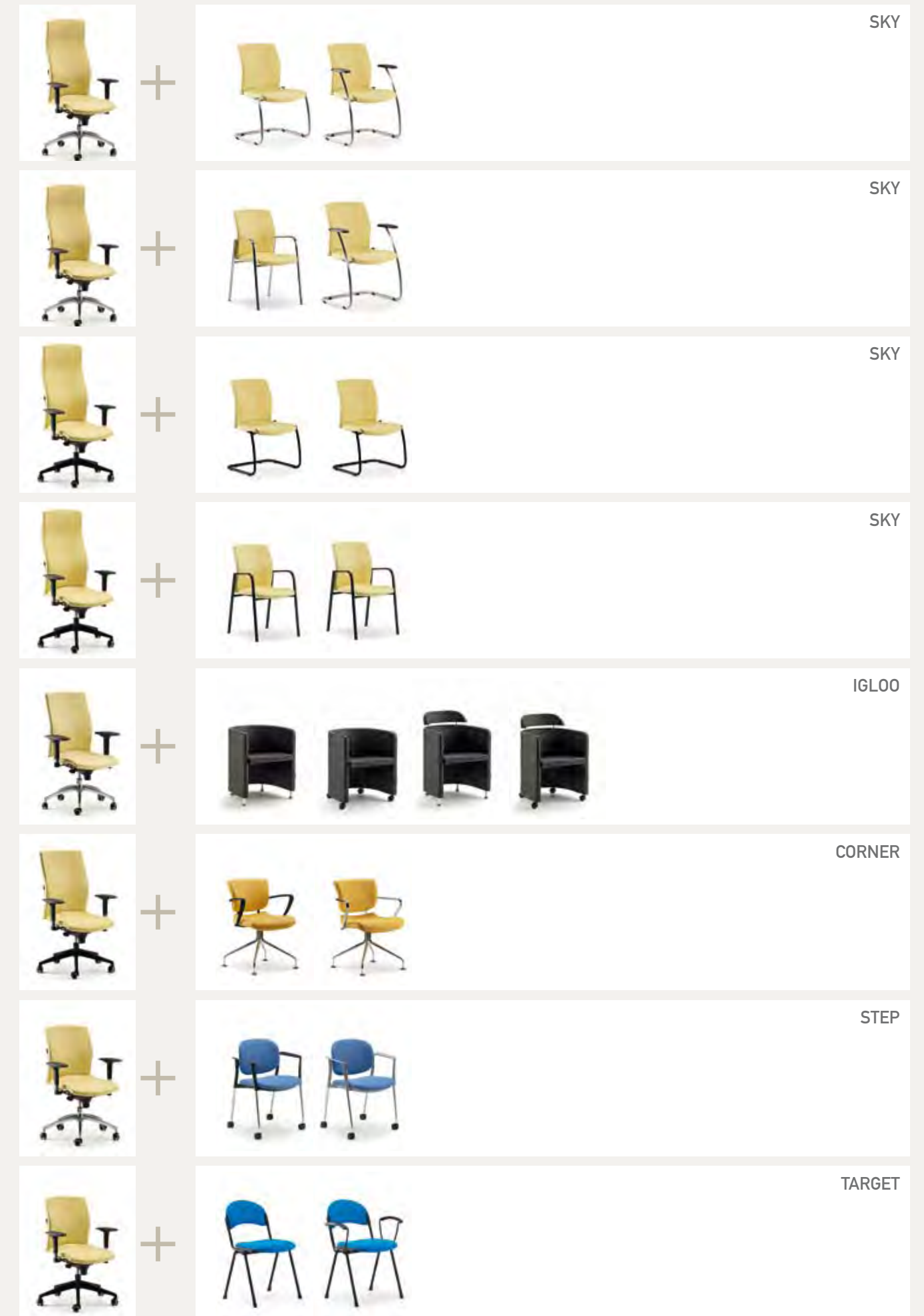



+ SWEET

SWEET



S090



S093



S090

SWEET

La serie Sweet assume il ruolo della seduta perfetta per un manager che necessita una poltrona comoda con un'estetica moderna.

The Sweet series chairs play a perfect role for managers in need of a comfortable chair with a modern aesthetic look.

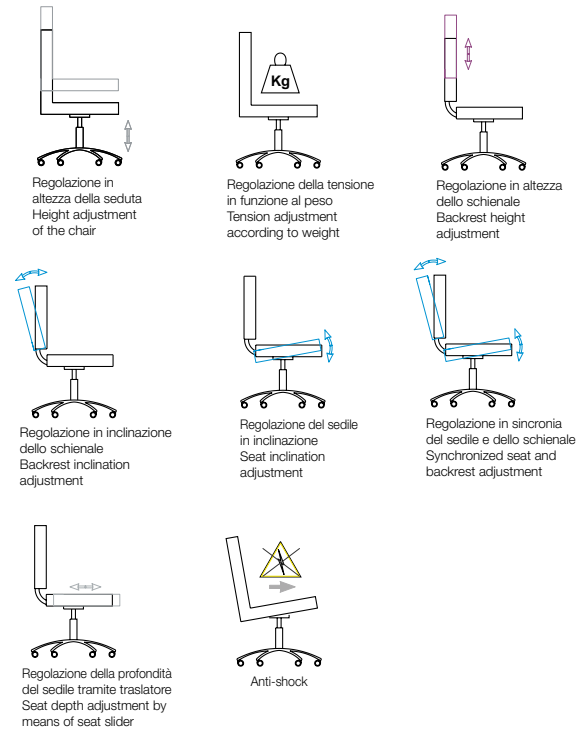

S098



S101



S096



S097

SWEET

1. Base a 5 razze in alluminio pressofuso spazzolato e lucidato.
2. Ruote piroettanti a doppia battitura gommata diametro 65 mm.
3. Alzo a gas tramite pompa a gas.
4. Movimenti:
 - piastra a gas (A) con leva per il comando della regolazione in altezza;
 - movimento sincronizzato (R) con 2 leve per blocco-sblocco in 5 posizioni con anti-shock, volantino per regolare la tensione dello schienale in base al peso, regolazione in altezza dello schienale tramite sistema up-down;
 - movimento asincrono (Q) con 3 leve per blocco-sblocco dello schienale in 4 posizioni con anti-shock, manopola per regolare la tensione dello schienale in base al peso, regolazione in altezza dello schienale tramite sistema up-down.
5. Sedile in multistrato di faggio e pioppo curvato spessore 12 mm.
6. Schienale in multistrato di faggio e pioppo curvato spessore 12 mm.
7. Braccioli:
 - in poliuretano con inserto in acciaio;
 - in nylon nero.
8. Poltrone fisse:
 - visitatore a slitta in acciaio cromato con braccioli incorporati e pad in nylon nero.
9. Imbottiture in resine poliuretatiche ignifughe classe 11M.
10. Rivestimenti in base ns. cartella colori o tessuto cliente.
 - Opzionale traslatore (TR) per la regolazione del sedile in profondità che consente 5 posizioni di blocco tramite pulsante posto sotto il sedile.
11. Norme di riferimento
 - poltrone girevoli ed elevabili En 1335;
 - poltrone non regolabili in altezza En 13761;
 - normative Uni vigenti;
 - solo a richiesta omologazione classe 11M con tessuto Categoria L con sovrapprezzo del 10%.

1. Five star base in polished die cast aluminium.
2. Wheel castors twin rubber diameter 65 mm.
3. Gas lift.
4. Movements:
 - gas plate (A) with lever to regulate chair height;
 - synchronized movement (R) with 2 levers for block-unblock in 5 working positions with anti-shock and pommel for tension regulation of the backrest according to weight and up-down system for backrest height adjustment;
 - synchronized "point effect" movement (Q) with 3 levers for block-unblock of backrest in 4 working positions with anti-shock, pommel for tension regulation of the backrest according to weight, seat adjustment in all inclined positions, height adjustable backrest with up-down system.
5. Seat made of curved beech and poplar wood in multiple layers thickness 12 mm.
6. Backrest made of curved beech and poplar wood in multiple layers thickness 12 mm.
7. Armrests:
 - in polyurethane with steel insert;
 - in black nylon.
8. Visitor chairs:
 - chromed steel cantilever chair with incorporated armrests and black nylon pad.
9. Inner Upholstery in expanded flame retardant polyurethane class 11M
10. Covering according to our fabric colour chart or by customer's fabrics.
 - Optional seat slider (TR) for depth adjustment of the seat in 5 blocking positions with under seat push button.
11. Reference regulation
 - En 1335 swivel and lift chair;
 - En 13761 visitor chair;
 - Uni regulations;
 - Only on approval request, 11M class with category L fabric cost an extra 10%.



Bracciolo in poliuretano
Polyurethane armrest

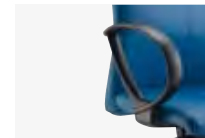

Bracciolo in nylon nero
Black nylon armrest



Bracciolo per telaio slitta
Cantilever visitor chair
armrest



Base in alluminio
Aluminium base

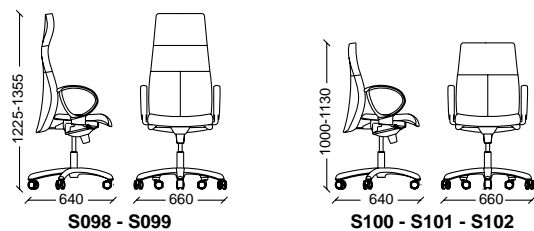
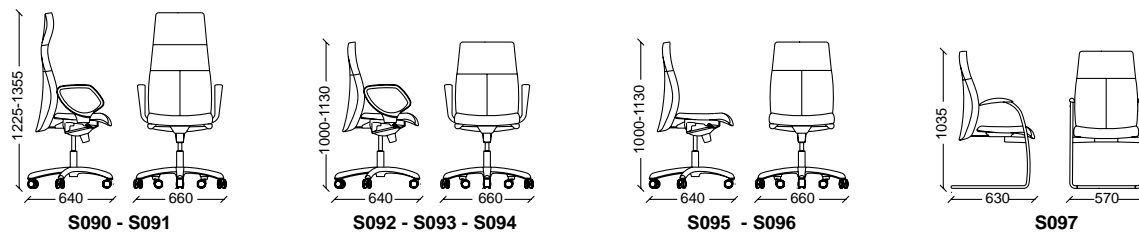

NOVITÀ - NEW

Personalizzazione cliente
Customer personalization

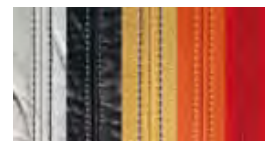

Possibilità di avere le cuciture di colore diverso dal rivestimento
Possibility to have different seam colour compared to upholstery

ABBINAMENTI / COMBINATIONS

Il trittico tradizionale è quello che è composto da prodotti coordinati della stessa serie, ma non deve essere una regola. La Seipo srl propone alcuni abbinamenti contemporanei per arredare il proprio ufficio al meglio. Naturalmente, le possibili combinazioni sono molteplici e di conseguenza gioca un ruolo non indifferente nel prezzo finale complessivo. Adesso puoi davvero comporre il tuo trittico ideale tenendo conto di una vasta scelta di modelli, di finiture, di design e di prezzo su misura al proprio budget.

The traditional triptych of chairs is usually composed of coordinated products from the same series, this does not have to be a rule. Seipo srl suggests some contemporary combinations in order for you to furnish your office at its best. Naturally, the possible matchings are numerous and for this reason play a key role in determining the final price. Now you can really create your ideal set of chairs by considering a vast choice of models, finishes, designs and the right price to meet your budget.

	+		SWEET
	+		VIEW
	+		FLEX
	+		FLAG
	+		CRONO
	+		STEP
	+		STEP
	+		TARGET



+ TELA

TELA



TL90



TL99



La vera forza della serie Tela deriva dall'insieme di una struttura importante, ergonomica e versatile.

The true strength of the Tela series derives from an ensemble of a significant structure, ergonomics and versatility.



TL70



TL92



TL95



TL97



TL98



TL72



TL75



TL77



TL79



TL78

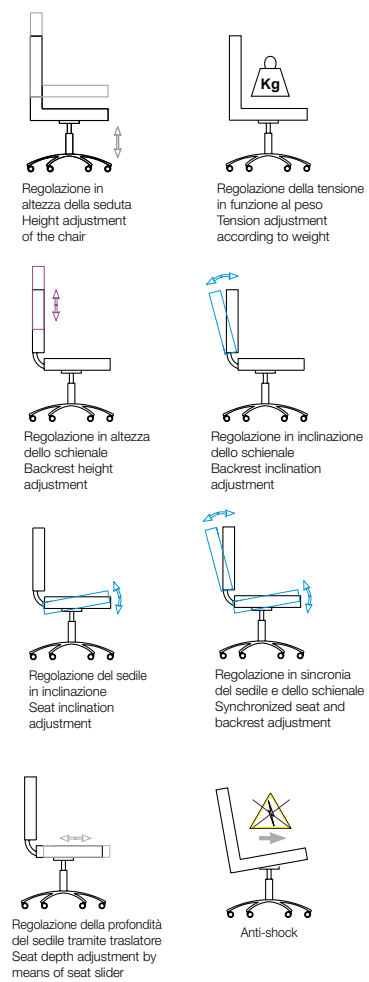

TELA

La serie Tela disponibile anche in versione rete, un'eleganza che non sfugge all'occhio ed allo stesso tempo colpisce per la sua affidabilità.

The Tela series is available with a net backrest, an elegance that cannot be overlooked and is also quite striking for its dependability.



TL61



TL63



TL65



TL67



TELA

- Base a 5 razze:
 - in alluminio pressofuso spazzolato e lucidato;
 - in nylon nero caricato con fibre di vetro.
- Ruote piroettanti a doppia battitura gommata diametro 65 mm.
- Alzo a gas tramite pompa a gas.
- Movimenti:
 - piastra a gas (A) con leva per il comando della regolazione in altezza;
 - movimento sincronizzato (R) con 2 leve per blocco-sblocco in 5 posizioni con anti-shock, volantino per regolare la tensione dello schienale in base al peso, regolazione in altezza dello schienale tramite sistema up-down;
 - movimento asincrono (Q) con 3 leve per blocco-sblocco dello schienale in 4 posizioni con anti-shock, manopola per regolare la tensione dello schienale in base al peso, regolazione del sedile in tutte le posizioni d'inclinazione, regolazione in altezza dello schienale tramite sistema up-down;
 - opzionale traslatore (TR) per la regolazione del sedile in profondità che consente 5 posizioni di blocco tramite pulsante posto sotto il sedile.
- Sedile con interno in acciaio incorporato nel nylon.
- Schienale:
 - cornice in nylon nero caricata in fibre di vetro rivestita con la rete (versione rete);
 - cornice in nylon nero caricata in fibre di vetro (versione imbottita).
- Poggiatesta in nylon nero imbottito e regolabile in inclinazione.
- Braccioli in nylon nero regolabili in altezza.
- Cassetta porta oggetti in nylon nero.
- Poltrone fisse:
 - visitatore a slitta tubolare a sezione tonda diametro 25 mm in acciaio verniciato nero o cromato senza braccioli;
 - visitatore a slitta tubolare a sezione tonda diametro 25 mm in acciaio verniciato nero o cromato con braccioli fissi in nylon nero.
- Imbottiture in resine poliuretaniche ignifughe classe 1IM.
- Rivestimenti in base ns. cartella colori o tessuto cliente.
- Norme di riferimento
 - poltrone girevoli ed elevabili En 1335
 - poltrone non regolabili in altezza En 13761
 - normative Uni vigenti
 - solo a richiesta omologazione classe 1IM con tessuto Categoria L con sovrapprezzo del 10%.

- Five star base:
 - in polished die cast aluminium;
 - in black nylon with reinforced fibre glass.
- Wheel castors twin rubber diameter 65 mm.
- Gas lift.
- Movements:
 - gas plate (A) with lever to regulate chair height.
 - synchronized movement (R) with 2 levers for block-unblock in 5 working positions with anti-shock and pommel for tension regulation of the backrest according to weight and up-down system for backrest height adjustment;
 - synchronized "point effect" movement (Q) with 3 levers for block-unblock of backrest in 4 working positions with anti-shock, pommel for tension regulation of the backrest according to weight, seat adjustment in all inclined positions, height adjustable backrest with up-down system;
 - optional seat slider (TR) for depth adjustment of the seat in 5 blocking positions with under seat push button.
- Seat made of steel incorporated in nylon.
- Schienale:
 - black nylon fibre glass frame covered with net fabric (net version);
 - black nylon fibre glass frame (upholstered version).
- Headrest in upholstered black nylon and adjustable in inclination.
- Armrests in black nylon adjustable in height.
- Accessories drawer in black nylon.
- Visitor chairs:
 - chromed steel or black varnished tubular steel cantilever round frame diameter 25 mm without armrests;
 - chromed steel or black varnished tubular steel cantilever round frame diameter 25 mm with fixed black nylon armrests.
- Inner Upholstery in expanded flame retardant polyurethane class 1IM
- Covering according to our fabric colour chart or by customer's fabrics.
- Reference regulation
 - En 1335 swivel and lift chair;
 - En 13761 visitor chair;
 - Uni regulations;
 - Only on approval request, 1IM class with category L fabric cost an extra 10%.

TL90 TL92 TL95 TL97 TL99 TL98

TL70 TL72 TL75 TL77 TL79 TL78

TL81 TL83 TL85 TL87 TL89 TL88

TL61 TL63 TL65 TL67 TL69 TL68

TL60 - TL61 - TL70 - TL71
TL80 - TL81 - TL90 - TL91

TL62 - TL63 - TL72 - TL93
TL82 - TL83 - TL-92 - TL93

TL64 - TL65 - TL66
TL74 - TL75 - TL76
TL84 - TL85 - TL86
TL94 - TL95 - TL96

TL67 - TL77
TL87 - TL97

TL68 - TL78
TL88 - TL98

TL69 - TL79
TL89 - TL99

Bracciolo fisso per slitta
Fixed cantilever visitor chair armrest

Bracciolo in nylon regolabile
Adjustable nylon armrest

Cassetto sottosedile
Underseat drawer

Poggiatesta regolabile
Adjustable headrest

Base in alluminio
Aluminium base

Base in nylon nero
Black nylon base

Possibilità di avere le cuciture di colore diverso dal rivestimento
Possibility to have different seam colour compared to upholstery

NOVITÀ - NEW
Personalizzazione cliente
Customer personalization

ABBINAMENTI / COMBINATIONS

Il trittico tradizionale è quello che è composto da prodotti coordinati della stessa serie, ma non deve essere una regola. La Seipo srl propone alcuni abbinamenti contemporanei per arredare il proprio ufficio al meglio. Naturalmente, le possibili combinazioni sono molteplici e di conseguenza gioca un ruolo non indifferente nel prezzo finale complessivo. Adesso puoi davvero comporre il tuo trittico ideale tenendo conto di una vasta scelta di modelli, di finiture, di design e di prezzo su misura al proprio budget.

The traditional triptych of chairs is usually composed of coordinated products from the same series, this does not have to be a rule. Seipo srl suggests some contemporary combinations in order for you to furnish your office at its best. Naturally, the possible matchings are numerous and for this reason play a key role in determining the final price. Now you can really create your ideal set of chairs by considering a vast choice of models, finishes, designs and the right price to meet your budget.

TELA

TELA

FLAG

CRONO

TELA

TELA

FLAG

STEP



+ GENIO

GENIO

La serie Genio è un vero esemplare del made in Italy che sprigiona design, funzionalità e pura bellezza.

The Genio series is a true example of a made in Italy product with a sparkling design, great functionality and pure beauty.

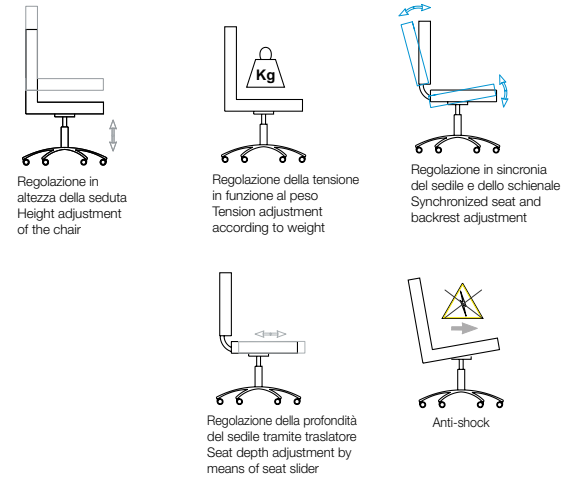

GN15



GN15



GN15



GN20



GENIO

Si respira un'aria di freschezza con la serie Genio in rete con base in alluminio o in acciaio verniciato nero.

The net backrest version of the Genio chair with an aluminium die cast or black varnished steel base is like a fresh breath of air.



GN30



GN25

GN30



GN25

GN30

GENIO

- Base a 5 razze:
 - in alluminio pressofuso spazzolato e lucidato;
 - in nylon nero caricato con fibre di vetro.
 - Ruote piroettanti a doppia battitura gommata diametro 65 mm.
 - Alzo a gas tramite pompa a gas.
 - Movimento sincronizzato (I) con 3 leve per il blocco-sblocco in 6 posizioni con con anti-shock, manopola per regolare la tensione dello schienale in base al peso.
 - Traslatore per la regolazione del sedile in profondità che consente 8 posizioni di blocco tramite pulsante posto sotto il sedile.
 - Sedile con interno in nylon e sottosedile in nylon caricato in fibre di vetro.
 - Schienaletto:
 - imbottito con interno in nylon e coperture in nylon caricato con fibre di vetro;
 - in rete con cornice a vista in nylon rinforzato con fibre di vetro.
 - Lombare regolabile in altezza.
 - Braccioli in nylon con poggia braccia in poliuretano regolabili in altezza.
 - Imbottiture in resine poliuretatiche ignifughe classe 11M
 - Rivestimenti in base ns. cartella colori o tessuto cliente.
 - Norme di riferimento
 - poltrone girevoli ed elevabili En 1335;
 - poltrone non regolabili in altezza En 13761;
 - normative Uni vigenti;
 - solo a richiesta omologazione classe 11M con tessuto Categoria L con sovrapprezzo del 10%.
- Five star base:
 - in polished die cast aluminium;
 - in black nylon with reinforced fibre glass.
 - Wheel castors twin rubber diameter 65 mm.
 - Gas lift.
 - Synchronized movement (I) with 3 levers for block-unblock in 6 working positions with anti-shock and pommel for tension regulation of the backrest according to weight.
 - Seat slider for depth adjustment of the seat in 8 blocking positions with under seat push button.
 - Seat inner and under seat made of nylon with reinforced fibre glass.
 - Backrest:
 - upholstered with inner and outer nylon backrest with reinforced fibre glass;
 - in net with nylon reinforced fibre glass frame.
 - Lumbar support adjustable in height.
 - Armrests in nylon with polyurethane pad, adjustable in height.
 - Inner Upholstery in expanded flame retardant polyurethane class 11M
 - Covering according to our fabric colour chart or by customer's fabrics.
 - Reference regulation
 - En 1335 swivel and lift chair;
 - En 13761 visitor chair;
 - Uni regulations;
 - Only on approval request, 11M class with category L fabric cost an extra 10%.



Braccioli regolabili
Adjustable armrest



Base in alluminio
Aluminium base



Base in nylon nero
Black nylon base



NOVITÀ - NEW

Personalizzazione cliente
Customer personalization

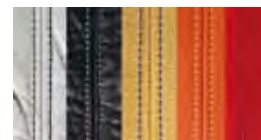

Possibilità di avere le cuciture di colore diverso dal rivestimento
Possibility to have different seam colour compared to upholstery

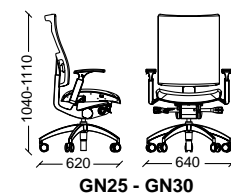
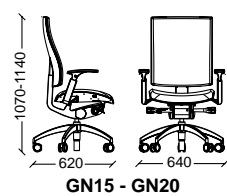

ABBINAMENTI / COMBINATIONS

Il trittico tradizionale è quello che è composto da prodotti coordinati della stessa serie, ma non deve essere una regola. La Seipo srl propone alcuni abbinamenti contemporanei per arredare il proprio ufficio al meglio. Naturalmente, le possibili combinazioni sono molteplici e di conseguenza gioca un ruolo non indifferente nel prezzo finale complessivo. Adesso puoi davvero comporre il tuo trittico ideale tenendo conto di una vasta scelta di modelli, di finiture, di design e di prezzo su misura al proprio budget.

The traditional triptych of chairs is usually composed of coordinated products from the same series, this does not have to be a rule. Seipo srl suggests some contemporary combinations in order for you to furnish your office at its best. Naturally, the possible matchings are numerous and for this reason play a key role in determining the final price. Now you can really create your ideal set of chairs by considering a vast choice of models, finishes, designs and the right price to meet your budget.

	+		FLEX
	+		FLAG
	+		FLEX
	+		CRONO
	+		FLY
	+		FLAG
	+		FLAG
	+		STEP



+ BAYS

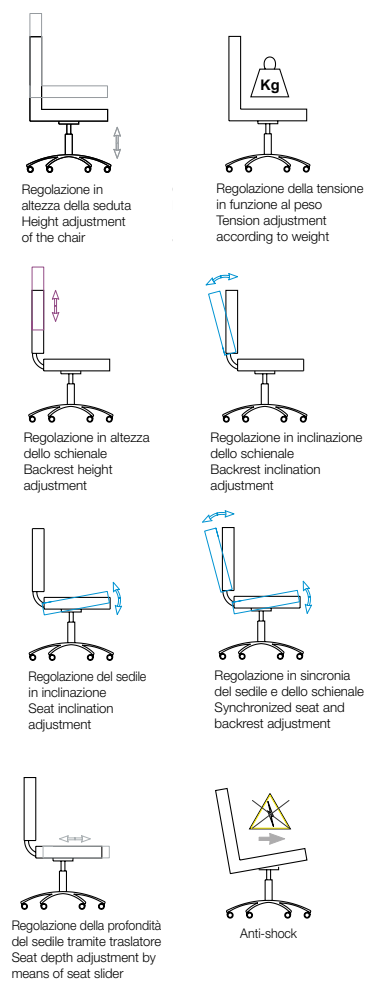

BAYS

La serie Bays versione nera manifesta tutte le qualità di questa seduta operativa nella sua versione più semplice.

The black Bays series version displays all of the qualities of a task chair in its simplest form.



BAYS

La serie Bays versione cromato è un esempio di una seduta operativa completa di varie accessori a scelta.

The chromed Bays series version is an example of a complete task chair with various accessories to choose from.



BY535



BY534



BY411



BY451



BY491



BY523



BY413



BY453



BY493



BY530





BY601

BY614

BY620

BY624

BAYS

La serie Bays versione grigia nasce per soddisfare l'esigenza della seduta operativa con un tocco di colore moderno.

The grey Bays series version originates to satisfy the need for a modern task chair with a touch of colour.



BY607



BY625



BY626

BAYS NERA

1. Base a 5 razze in nylon nero caricato con fibre di vetro.
2. Ruote piroettanti a doppia battitura gommata diametro 50 mm.
3. Alzo a gas tramite pompa a gas.
4. Movimenti:
 - contatto permanente (O) con volantino per la regolazione in inclinazione dello schienale in tutte le posizioni con anti-shock, regolazione in altezza dello schienale tramite sistema up-down;
 - movimento sincronizzato (R) con 2 leve per blocco-sblocco in 5 posizioni con anti-shock, volantino per regolare la tensione dello schienale in base al peso, regolazione in altezza dello schienale tramite sistema up-down;
 - movimento asincrono (Q) con 3 leve per blocco-sblocco dello schienale in 4 posizioni con anti-shock, manopola per regolare la tensione dello schienale in base al peso, regolazione del sedile in tutte le posizioni d'inclinazione, regolazione in altezza dello schienale tramite sistema up-down.
5. Traslatore per la regolazione del sedile in profondità che consente 5 posizioni di blocco tramite pulsante posto sotto il sedile.
6. Sedile:
 - con interno in multistrato di faggio e pioppo curvato con coperture in nylon (poltrone visitatore).
 - con interno in acciaio incorporato nel nylon.
7. Schienale:
 - con interno in polipropilene con coperture in nylon nero.
8. Poggiatesta con lama di acciaio portante spessore 4 mm regolabile in altezza con sistema up-down idoneamente imbottito.
9. Braccioli:
 - con staffa in acciaio verniciato nero e poggia braccia in nylon nero fissi;
 - con staffa in acciaio cromato e pad in poliuretano regolabili in altezza e in larghezza.
10. Poltrone fisse:
 - visitatore a slitta in acciaio verniciato nero senza braccioli;
 - visitatore a slitta in acciaio cromato con braccioli incorporati e pad in poliuretano;
 - visitatore a slitta in acciaio verniciato nero con braccioli in nylon nero.
11. Imbottiture in resine poliuretane ignifughe classe 11M.
12. Rivestimenti in base ns. cartella colori o tessuto cliente.
13. Norme di riferimento
 - poltrone girevoli ed elevabili En 1335;
 - poltrone non regolabili in altezza En 13761;
 - normative Uni vigenti;
 - solo a richiesta omologazione classe 11M con tessuto Categoria L con sovrapprezzo del 10%.

1. Five star base in black nylon with reinforced fibre glass.
2. Wheel castors twin rubber diameter 50 mm.
3. Gas lift.
4. Movements:
 - Permanent contact (O) with pommel for regulation of backrest inclination in all positions with anti-shock, height adjustable backrest with up-down system;
 - Synchronized movement (R) with 2 levers for block-unblock in 5 working positions with anti-shock and pommel for tension regulation of the backrest according to weight and up-down system for backrest height adjustment;
 - Synchronized "point effect" movement (Q) with 3 levers for block-unblock of backrest in 4 working positions with anti-shock, pommel for tension regulation of the backrest according to weight, seat adjustment in all inclined positions, height adjustable backrest with up-down system.
5. Seat slider for depth adjustment of the seat in 5 blocking positions with under seat push button.
6. Seat:
 - made of curved beech and poplar wood in multiple layers with nylon covering (visitor chairs).
 - made of steel incorporated in nylon.
7. Backrest:
 - made of polypropylene with black nylon cover.
8. Headrest upholstered with chromed steel all-bearing blade thickness 4 mm height adjustable with up-down system.
9. Armrests:
 - black varnished steel support with fixed black nylon pad;
 - chromed steel support with polyurethane pad adjustable in height and width.
10. Visitor chairs:
 - black varnished steel cantilever chair without armrests;
 - black varnished steel cantilever chair with incorporated armrests and polyurethane pad;
 - black varnished steel cantilever chair with fixed black nylon armrests.
11. Inner Upholstery in expanded flame retardant polyurethane class 11M
12. Covering according to our fabric colour chart or by customer's fabrics.
13. Reference regulation
 - En 1335 swivel and lift chair;
 - En 13761 visitor chair;
 - Uni regulations;
 - Only on approval request, 11M class with category L fabric cost an extra 10%.

BAYS CROMATA

1. Base a 5 razze in alluminio pressofuso spazzolato e lucidato.
2. Ruote piroettanti a doppia battitura gommata diametro 50 mm.
3. Alzo a gas tramite pompa a gas.
4. Movimenti:
 - contatto permanente (O) con volantino per la regolazione in inclinazione dello schienale in tutte le posizioni con anti-shock, regolazione in altezza dello schienale tramite sistema up-down;
 - movimento sincronizzato (R) con 2 leve per blocco-sblocco in 5 posizioni con anti-shock, volantino per regolare la tensione dello schienale in base al peso, regolazione in altezza dello schienale tramite sistema up-down;
 - movimento asincrono (Q) con 3 leve per blocco-sblocco dello schienale in 4 posizioni con anti-shock, manopola per regolare la tensione dello schienale in base al peso, regolazione del sedile in tutte le posizioni d'inclinazione, regolazione in altezza dello schienale tramite sistema up-down.
5. Traslatore per la regolazione del sedile in profondità che consente 5 posizioni di blocco tramite pulsante posto sotto il sedile.
6. Sedile:
 - con interno in multistrato di faggio e pioppo curvato con coperture in nylon (poltrone visitatore);
 - con interno in acciaio incorporato nel nylon.
7. Schienale:
 - con interno in polipropilene con coperture in nylon nero.
8. Poggiatesta con lama di acciaio portante spessore 4 mm regolabile in altezza con sistema up-down idoneamente imbottito.
9. Braccioli:
 - con staffa in acciaio cromato e poggia braccia in nylon nero fissi;
 - con staffa in acciaio cromato e pad in poliuretano regolabili in altezza e in larghezza.
10. Poltrone fisse:
 - visitatore a slitta in acciaio cromato senza braccioli;
 - visitatore a slitta in acciaio cromato con braccioli incorporati e pad in poliuretano;
 - visitatore a slitta in acciaio cromato con braccioli in nylon nero.
11. Imbottiture in resine poliuretane ignifughe classe 11M.
12. Rivestimenti in base ns. cartella colori o tessuto cliente.
13. Norme di riferimento
 - poltrone girevoli ed elevabili En1335;
 - poltrone non regolabili in altezza En13761;
 - normative Uni vigenti;
 - solo a richiesta omologazione classe 11M con tessuto Categoria L con sovrapprezzo del 10%.

1. Five star base in polished die cast aluminium.
2. Wheel castors twin rubber diameter 50 mm.
3. Gas lift.
4. Movements:
 - Permanent contact (O) with pommel for regulation of backrest inclination in all positions with anti-shock, height adjustable backrest with up-down system;
 - Synchronized movement (R) with 2 levers for block-unblock in 5 working positions with anti-shock and pommel for tension regulation of the backrest according to weight and up-down system for backrest height adjustment;
 - Synchronized "point effect" movement (Q) with 3 levers for block-unblock of backrest in 4 working positions with anti-shock, pommel for tension regulation of the backrest according to weight, seat adjustment in all inclined positions, height adjustable backrest with up-down system.
5. Seat slider for depth adjustment of the seat in 5 blocking positions with under seat push button.
6. Seat:
 - made of curved beech and poplar wood in multiple layers with nylon covering (visitor chairs);
 - made of steel incorporated in nylon.
7. Backrest:
 - made of polypropylene with black nylon cover.
8. Headrest upholstered with chromed steel all-bearing blade thickness 4 mm height adjustable with up-down system.
9. Armrests:
 - chromed steel support with fixed black nylon pad;
 - chromed steel support with polyurethane pad adjustable in height and width.
10. Visitor chairs:
 - chromed steel cantilever chair without armrests;
 - chromed steel cantilever chair with incorporated armrests and polyurethane pad;
 - chromed steel cantilever chair with fixed black nylon armrests.
11. Inner Upholstery in expanded flame retardant polyurethane class 11M
12. Covering according to our fabric colour chart or by customer's fabrics.
13. Reference regulation
 - En 1335 swivel and lift chair
 - En 13761 visitor chair
 - Uni regulations
 - Only on approval request, 11M class with category L fabric cost an extra 10%.

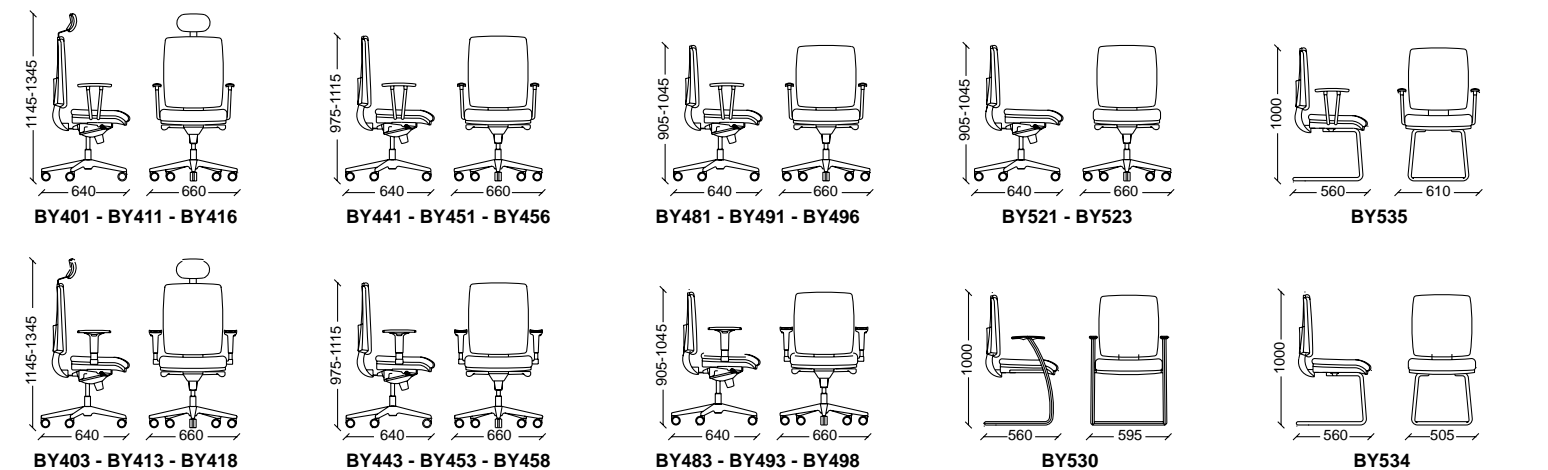
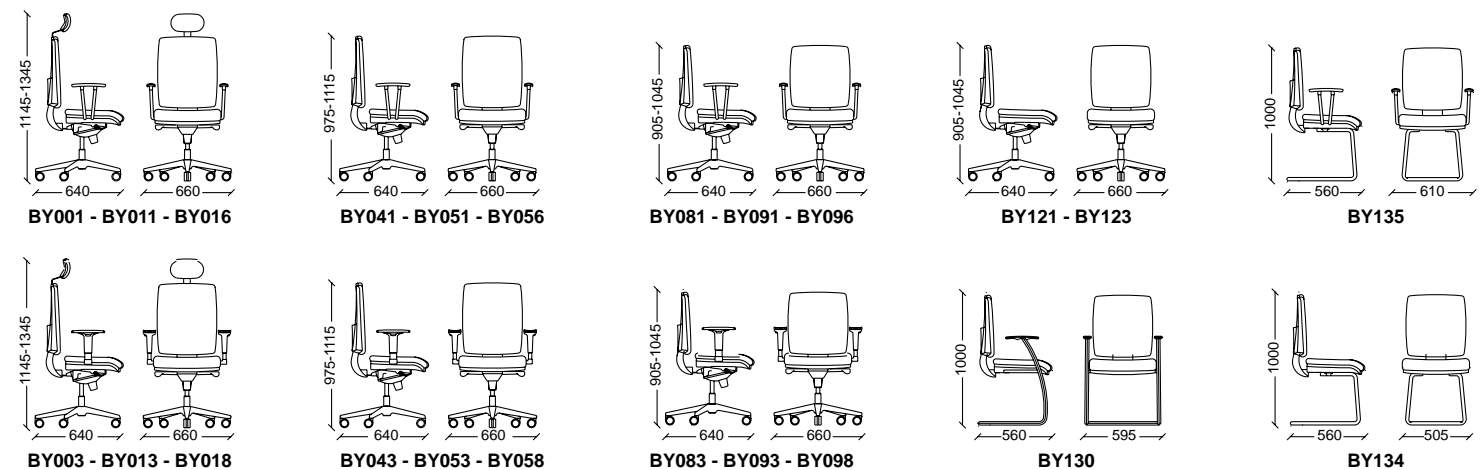

BAYS GRIGIA

1. Base a 5 razze in nylon grigio caricato con fibre di vetro.
2. Ruote piroettanti a doppia battitura gommata diametro 50 mm.
3. Alzo a gas tramite pompa a gas.
4. Movimenti:
 - contatto permanente (O) con volantino per la regolazione in inclinazione dello schienale in tutte le posizioni con anti-shock, regolazione in altezza dello schienale tramite sistema up-down;
 - movimento sincronizzato (R) con 2 leve per blocco-sblocco in 5 posizioni con anti-shock, volantino per regolare la tensione dello schienale in base al peso, regolazione in altezza dello schienale tramite sistema up-down;
 - movimento asincrono (Q) con 3 leve per blocco-sblocco dello schienale in 4 posizioni con anti-shock, manopola per regolare la tensione dello schienale in base al peso, regolazione del sedile in tutte le posizioni d'inclinazione, regolazione in altezza dello schienale tramite sistema up-down.
5. Sedile:
 - con interno in multistrato di faggio e pioppo curvato con coperture in nylon.
6. Schienale:
 - con interno in polipropilene con coperture in nylon grigio.
7. Poggiatesta con lama di acciaio portante spessore 4 mm regolabile in altezza con sistema up-down idoneamente imbottito.
8. Braccioli:
 - in nylon grigio fissi.
9. Poltrone fisse:
 - visitatore a slitta in acciaio verniciato alluminio senza braccioli;
 - visitatore a slitta in acciaio verniciato alluminio con braccioli incorporati e pad in nylon;
 - visitatore a slitta in acciaio verniciato alluminio con braccioli in nylon grigio.
10. Imbottiture in resine poliuretaniche ignifughe classe 11M
11. Rivestimenti in base ns. cartella colori o tessuto cliente.
12. Norme di riferimento
 - poltrone girevoli ed elevabili En 1335;
 - poltrone non regolabili in altezza En 13761;
 - normative Uni vigenti;
 - solo a richiesta omologazione classe 11M con tessuto Categoria L con sovrapprezzo del 10%.

1. Five star base in grey nylon with reinforced fibre glass.
2. Wheel castors twin rubber diameter 50 mm.
3. Gas lift.
4. Movements:
 - Permanent contact (O) with pommel for regulation of backrest inclination in all positions with anti-shock, height adjustable backrest with up-down system;
 - Synchronized movement (R) with 2 levers for block-unblock in 5 working positions with anti-shock and pommel for tension regulation of the backrest according to weight and up-down system for backrest height adjustment;
 - Synchronized "point effect" movement (Q) with 3 levers for block-unblock of backrest in 4 working positions with anti-shock, pommel for tension regulation of the backrest according to weight, seat adjustment in all inclined positions, height adjustable backrest with up-down system.
5. Seat:
 - made of curved beech and poplar wood in multiple layers with nylon covering.
6. Backrest:
 - made of polypropylene with grey nylon cover.
7. Headrest upholstered with chromed steel all-bearing blade thickness 4 mm height adjustable with up-down system.
8. Armrests with aluminium varnished steel support and fixed grey nylon pad.
9. Visitor chairs:
 - aluminium varnished steel cantilever chair without armrests.
 - aluminium varnished steel cantilever chair with incorporated armrests and polyurethane pad.
 - aluminium varnished steel cantilever chair with fixed grey nylon armrests.
10. Inner Upholstery in expanded flame retardant polyurethane class 11M
11. Covering according to our fabric colour chart or by customer's fabrics
12. Reference regulation
 - En 1335 swivel and lift chair;
 - En 13761 visitor chair;
 - Uni regulations;
 - Only on approval request, 11M class with category L fabric cost an extra 10%.



NOVITÀ - NEW

Personalizzazione cliente
Customer personalization

Base in nylon grigio
Grey nylon base



Possibilità di avere le cuciture di colore diverso dal rivestimento
Possibility to have different seam colour compared to upholstery

Poggiatesta regolabile
Adjustable headrest

Bracciolo per telaio a slitta
Cantilever visitor chair armrest

Bracciolo in acciaio verniciato grigio con pad in nylon
Grey varnished steel armrest with nylon pad

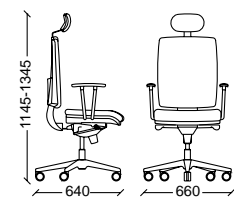

BY601 - BY603 - BY605

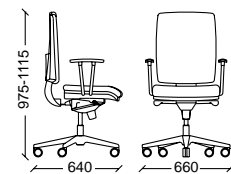

BY607 - BY609 - BY611

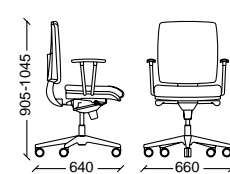

BY614 - BY616 - BY618

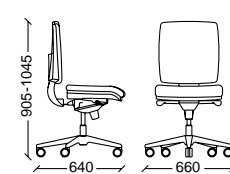

BY620 - BY621

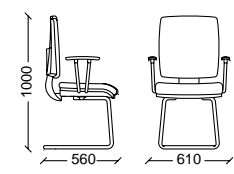

BY626

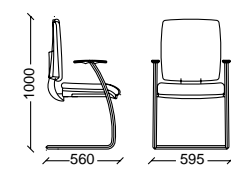

BY624

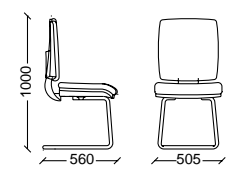

BY625

ABBINAMENTI / COMBINATIONS

Il trittico tradizionale è quello che è composto da prodotti coordinati della stessa serie, ma non deve essere una regola. La Seipo srl propone alcuni abbinamenti contemporanei per arredare il proprio ufficio al meglio. Naturalmente, le possibili combinazioni sono molteplici e di conseguenza gioca un ruolo non indifferente nel prezzo finale complessivo. Adesso puoi davvero comporre il tuo trittico ideale tenendo conto di una vasta scelta di modelli, di finiture, di design e di prezzo su misura al proprio budget.

The traditional triptych of chairs is usually composed of coordinated products from the same series, this does not have to be a rule. Seipo srl suggests some contemporary combinations in order for you to furnish your office at its best. Naturally, the possible matchings are numerous and for this reason play a key role in determining the final price. Now you can really create your ideal set of chairs by considering a vast choice of models, finishes, designs and the right price to meet your budget.

	+		BAYS
	+		FLEX
	+		CRONO
	+		BAYS
	+		STEP
	+		STEP
	+		BAYS
	+		STEP

+ CONNECT

CONNECT

La serie Connect offre un'ampia scelta di tipologia di sedute in versione imbottita con base e telai in acciaio verniciato nero.

The Connect series offers a broad choice of types of chairs in the upholstered version with black varnished steel bases and frames.



C124



C115



C115



C119



C101



C105



C111



C109



C122



C162

C161



C152



C148

C150

C149

La serie Connect con schienale in rete rigorosamente di colore nero con accessori in nylon bianco è un vero abbinamento dei colori più classici.

The Connect series with a black net backrest and accessories in white nylon is a fine combination of classic colours.

CONNECT

La serie Connect con base, braccioli e dietro schienale in nylon bianco è una vera delizia per l'occhio critico.

The Connect series with white nylon base, armrests and backrest cover is a true delight for the critical eye.



C152

C156

C160



C144

CONNECT

La serie Connect non finisce di stupire con i suoi modelli in rete abbinati a base e braccioli di colore nero degni di un vero ufficio moderno.

La serie Connect con schienale in rete versione slitta a visitatore è una piacevole sicurezza per l'interlocutore.

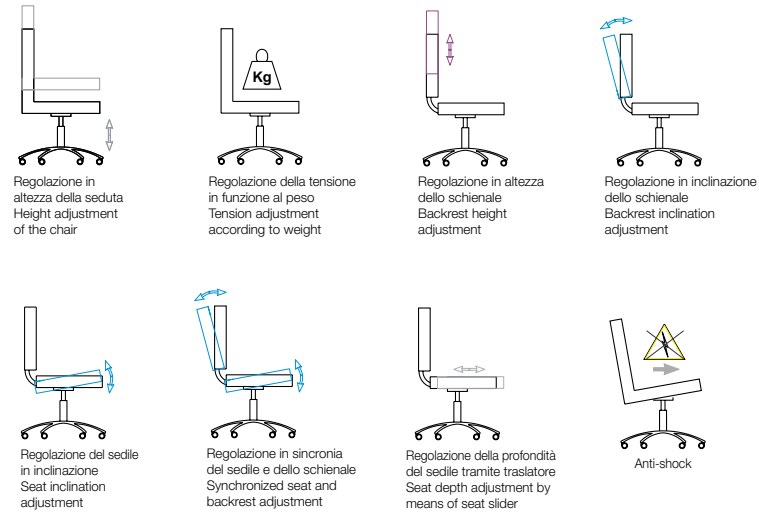

C141



La serie Connect con schienale in rete versione slitta a visitatore è una piacevole sicurezza per l'interlocutore.

The Connect net backrest cantilever visitor chair is a pleasant assurance for its user.



C131



C127



C139



C135



C137

CONNECT

- Base a 5 razze:
 - in nylon nero caricato con fibre di vetro;
 - in nylon bianco caricato con fibre di vetro.
- Ruote piroettanti a doppia battitura gommata diametro 50 mm.
- Alzo a gas tramite pompa a gas.
- Movimenti:
 - piastra a gas (A) con leva per il comando della regolazione in altezza;
 - contatto permanente (O) con volantino per la regolazione in inclinazione dello schienale in tutte le posizioni con anti-shock, regolazione in altezza dello schienale tramite sistema up-down;
 - movimento sincronizzato (R) con 2 leve per blocco-sblocco in 5 posizioni con anti-shock, volantino per regolare la tensione dello schienale in base al peso, regolazione in altezza dello schienale tramite sistema up-down;
 - movimento asincrono (Q) con 3 leve per blocco-sblocco dello schienale in 4 posizioni con anti-shock, manopola per regolare la tensione dello schienale in base al peso, regolazione in altezza dello schienale tramite sistema up-down.
- Traslatore per la regolazione del sedile in profondità che consente 5 posizioni di blocco tramite pulsante posto sotto il sedile.
- Sedile:
 - con interno in multistrato di faggio e pioppo curvato con coperture in nylon (poltrone visitatore);
 - con interno in acciaio incorporato nel nylon.
- Schienale:
 - con interno in polipropilene con coperture in nylon nero oppure bianco;
 - in rete con cornice a vista in acciaio.
- Braccioli:
 - in poliuretano nero fissi;
 - in nylon nero fissi;
 - in nylon bianco fissi.
- Poltrone fisse:
 - visitatore a slitta in acciaio verniciato nero con o senza braccioli;
 - visitatore a slitta in acciaio cromato con o senza braccioli.
- Imbottiture in resine poliuretaniche ignifughe classe 11M
- Rivestimenti in base ns. cartella colori o tessuto cliente.
- Norme di riferimento
 - poltrone girevoli ed elevabili En 1335;
 - poltrone non regolabili in altezza En 13761;
 - normative Uni vigenti;
 - solo a richiesta omologazione classe 11M con tessuto Categoria L con sovrapprezzo del 10%.

- Five star base:
 - in black nylon with reinforced fibre glass;
 - in white nylon with reinforced fibre glass.
- Wheel castors twin rubber diameter 50 mm.
- Gas lift.
- Movements:
 - gas plate (A) with lever to regulate chair height;
 - permanent contact (O) with pommel for regulation of backrest inclination in all positions with anti-shock, height adjustable backrest with up-down system;
 - synchronized movement (R) with 2 levers for block-unblock in 5 working positions with anti-shock and pommel for tension regulation of the backrest according to weight and up-down system for backrest height adjustment;
 - synchronized "point effect" movement (Q) with 3 levers for block-unblock of backrest in 4 working positions with anti-shock, pommel for tension regulation of the backrest according to weight, seat adjustment in all inclined positions, height adjustable backrest with up-down system.
- Seat slider for depth adjustment of the seat in 5 blocking positions with under seat push button.
- Seat:
 - made of curved beech and poplar wood in multiple layers with nylon covering (visitor chairs);
 - made of steel incorporated in nylon.
- Backrest:
 - made of polypropylene with black or white nylon cover;
 - in net with steel frame.
- Armrests:
 - in fixed black polyurethane;
 - in fixed black nylon;
 - in fixed white nylon.
- Visitor chairs:
 - black varnished steel cantilever chair with or without armrests;
 - chromed steel cantilever chair with or without armrests.
- Inner Upholstery in expanded flame retardant polyurethane class 11M
- Covering according to our fabric colour chart or by customer's fabrics.
- Reference regulation
 - En 1335 swivel and lift chair;
 - En 13761 visitor chair;
 - Uni regulations;
 - Only on approval request, 11M class with category L fabric cost an extra 10%.



ABBINAMENTI / COMBINATIONS

Il tritico tradizionale è quello che è composto da prodotti coordinati della stessa serie, ma non deve essere una regola. La Seipo srl propone alcuni abbinamenti contemporanei per arredare il proprio ufficio al meglio. Naturalmente, le possibili combinazioni sono molteplici e di conseguenza gioca un ruolo non indifferente nel prezzo finale complessivo. Adesso puoi davvero comporre il tuo tritico ideale tenendo conto di una vasta scelta di modelli, di finiture, di design e di prezzo su misura al proprio budget.

The traditional triptych of chairs is usually composed of coordinated products from the same series, this does not have to be a rule. Seipo srl suggests some contemporary combinations in order for you to furnish your office at its best. Naturally, the possible matchings are numerous and for this reason play a key role in determining the final price. Now you can really create your ideal set of chairs by considering a vast choice of models, finishes, designs and the right price to meet your budget.

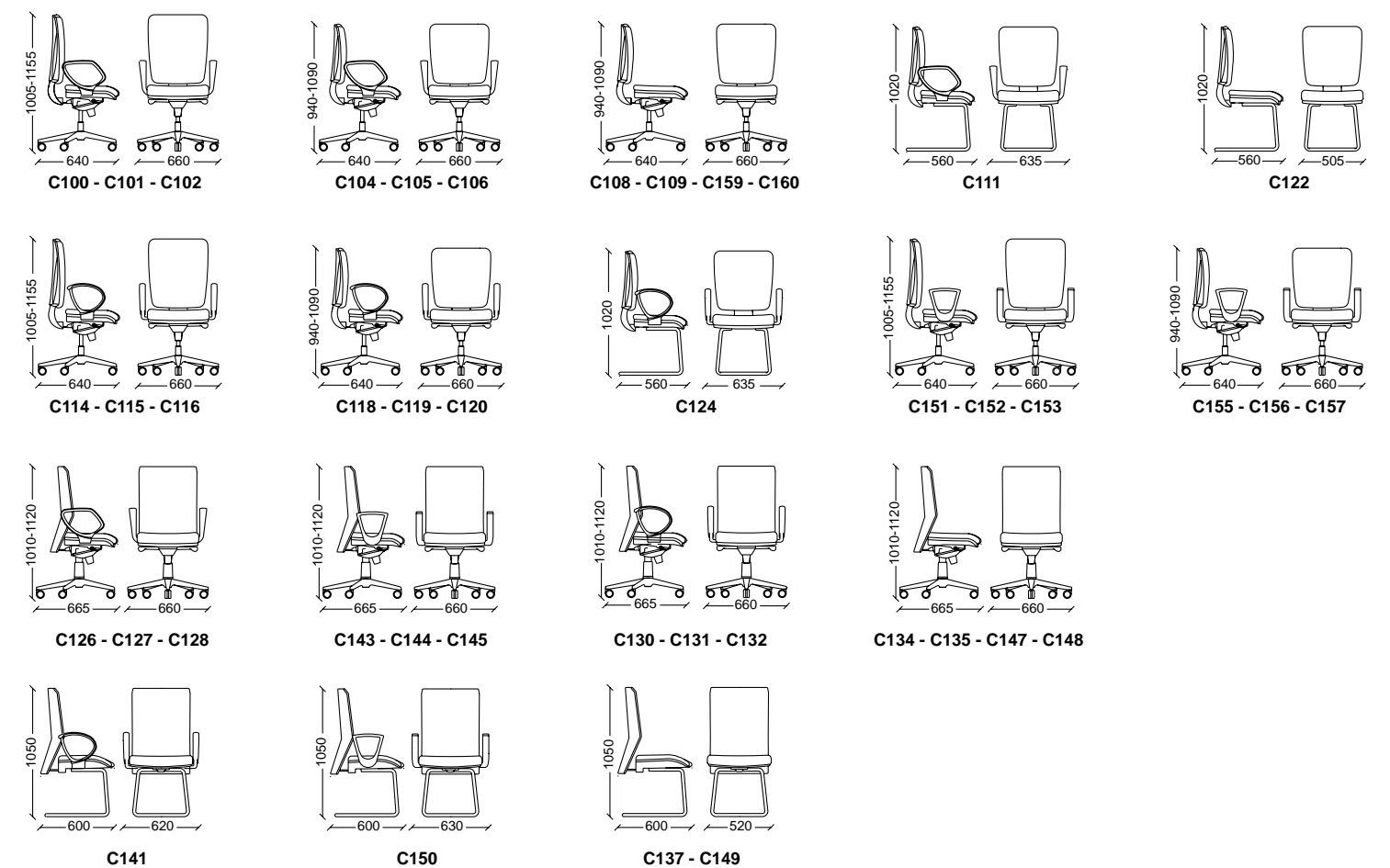
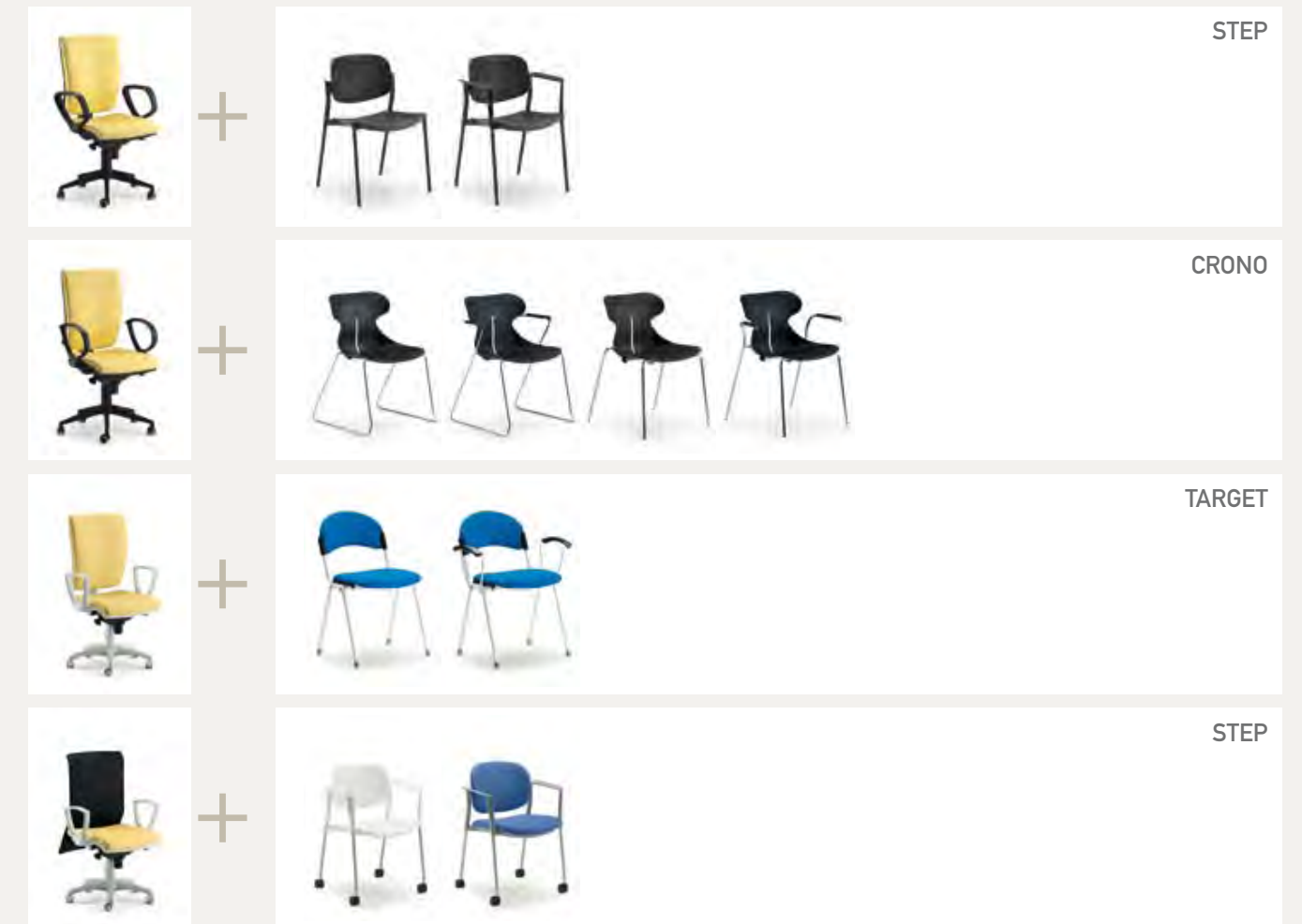



+ TENDER



TENDER

La serie Tender ci dimostra che a volte vale la pena fermare il tempo per ammirare il vero stile.

The Tender series is proof that at times it is worthy to stop time in order to admire never ending style.



TN01



TN02



TN03

TENDER

La serie Tender ci regala i suoi pouf per ambienti desiderosi di un tocco del passato nell'ufficio di oggi.

The Tender series offers its poufs for environments in search of a touch of the past for today's office.



TN06



TN04



TN07



TN05



TENDER

1. Telaio in tubolare di acciaio cromato diametro 20 mm spessore 2,5 mm base in acciaio cromato angolare spessore 5 mm.
2. Pouf singolo o a due posti struttura in legno
- con piedini in fibre di vetro cromati;
- con piedini in nylon a scomparsa.
3. Imbottiture in resine poliuretaniche ignifughe classe 1M
4. Rivestimenti in base ns. cartella colori o tessuto cliente.

1. Frame in tubular chromed steel diameter 20 mm, thickness 2,5 mm welded to steel angular base, thickness 5 mm.
2. Pouf single or two seater structure in wood
- chromed fibre glass feet.
- hidden nylon feet.
3. Inner Upholstery in expanded flame retardant polyurethane class 1M
4. Covering according to our fabric colour chart or by customer's fabrics.



TN01

TN02

TN03



TN04

TN05

TN06

TN07



NOVITÀ - NEW

Personalizzazione cliente
Customer personalization

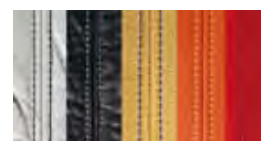

Possibilità di avere le cuciture di colore diverso dal rivestimento
Possibility to have different seam colour compared to upholstery

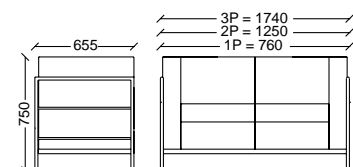

TN01 - TN02 - TN03

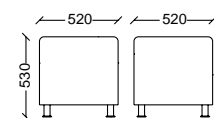

TN04

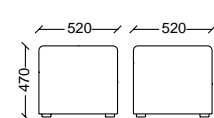

TN05

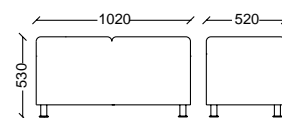

TN06

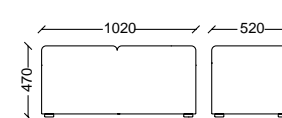

TN07



+ HAND



HAND

La serie Hand non può mancare in una sala attesa che necessita comfort, eleganza ed ispirazione.

The hand series is ideal for a waiting room in need of comfort, elegance and inspiration.



H12



H11



H13



H15



H14

HAND

La serie Hand con schienale rialzato rende ancora più appetibile questo divano che da un senso di lusso.

The Hand series with a raised backrest makes it even more attractive and expresses a sensation of luxury.



H16



H17



H18



H19



HAND

1. Telaio interamente in multistrato di legno.
2. Sedile e schienale con cinghie elastiche fissate alla struttura
- schienalino regolabile tramite innesti d'acciaio (H16, H17, H18, H19).
3. Piedini in nylon a scomparsa.
4. Imbottiture in resine poliuretaniche ignifughe classe 1M
5. Rivestimenti in base ns. cartella colori o tessuto cliente.

1. Frame in multilayered wood.
2. Seat and backrest with elastic straps fixed to the structure
- steel insert for backrest regulation (H16, H17, H18, H19).
3. Hidden nylon feet.
4. Inner Upholstery in expanded flame retardant polyurethane class 1M
5. Covering according to our fabric colour chart or by customer's fabrics.



NOVITÀ - NEW

Personalizzazione cliente
Customer personalization

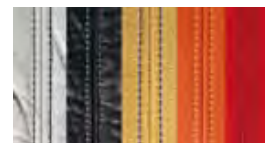

Possibilità di avere le cuciture di colore diverso dal rivestimento
Possibility to have different seam colour compared to upholstery

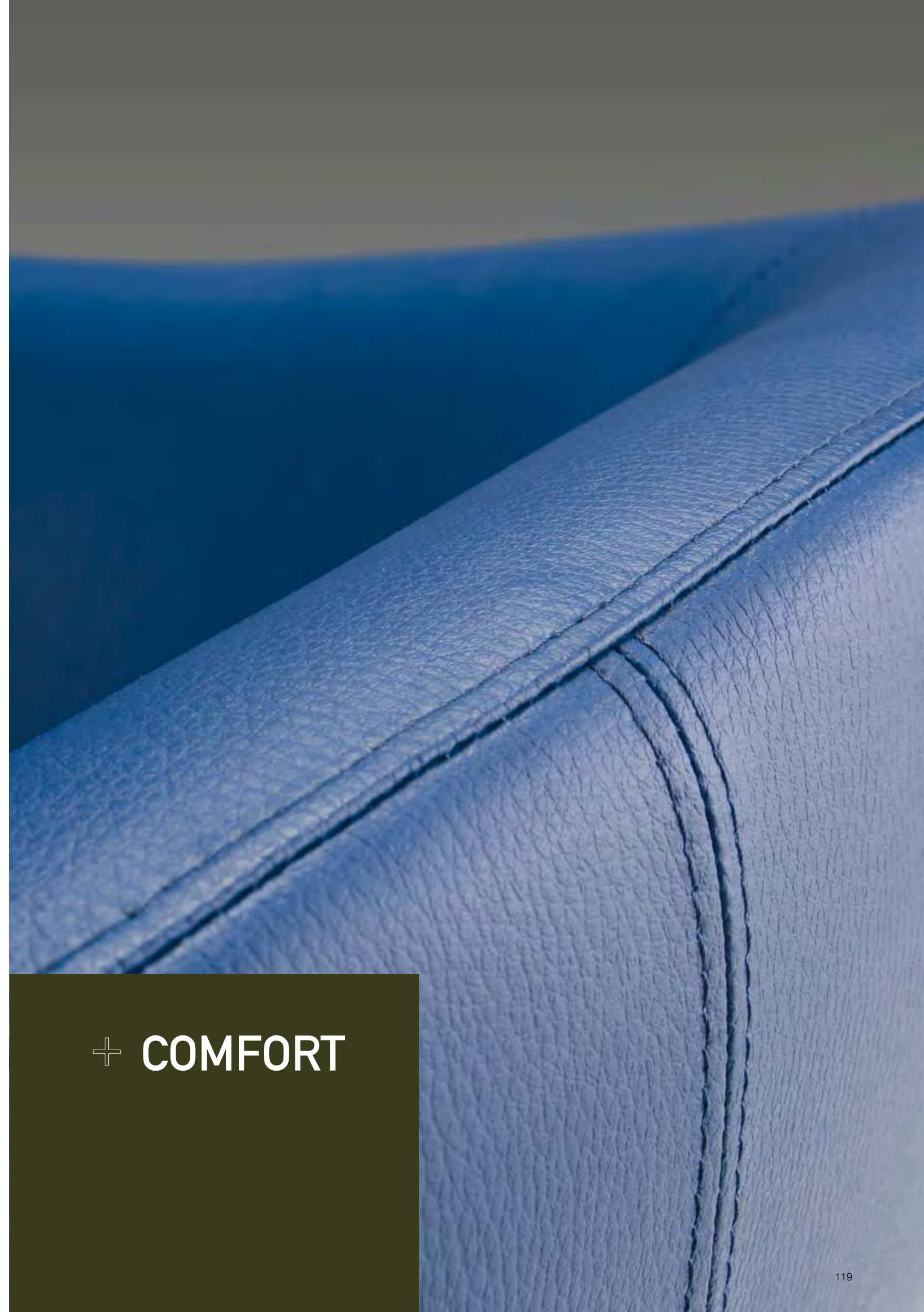
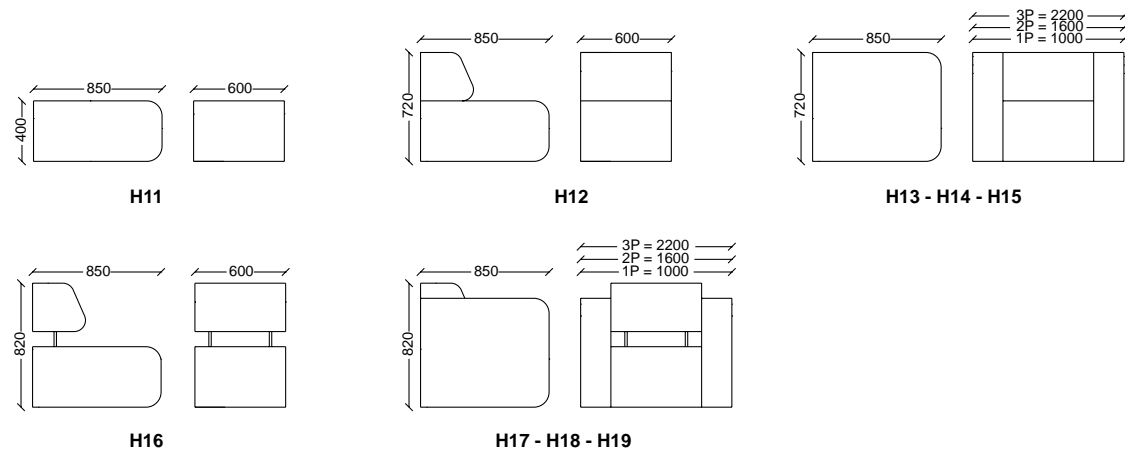

+ COMFORT

COMFORT



CM10



CM10

CM20

CM10



La serie Comfort versione divano o poltrona si distingue per la sua grande profondità e struttura indeformabile.

The Comfort series armchair and couch emphasize great depth and a crushproof structure.



CM30

COMFORT

1. Struttura interna in acciaio sagomato.
2. Piedini in alluminio con snodo per livellamento su pavimenti.
3. Meccanismo auto allineante che consente alla seduta di ritornare alla posizione iniziale (CM30).
4. Base tonda in acciaio cromato (CM30).
5. Imbottitura schiumato a freddo.
6. Rivestimenti in base ns. cartella colori o tessuto cliente.

1. Inner structure in shaped steel.
2. Feet in aluminium with joint for floor levelling.
3. Auto aligning mechanism allows for the chair to return to its initial position (CM30).
4. Base in round chromed steel (CM30).
5. Inner upholstery in cold foamed polyurethane.
6. Covering according to our fabric colour chart or by customer's fabrics.



CM10



CM20



CM30



NOVITÀ - NEW

Personalizzazione cliente
Customer personalization

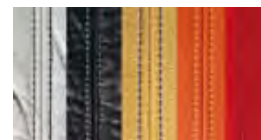

Possibilità di avere le cuciture di colore diverso dal rivestimento
Possibility to have different seam colour compared to upholstery

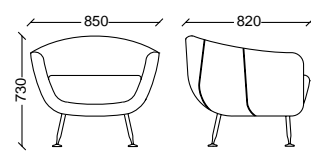

CM10

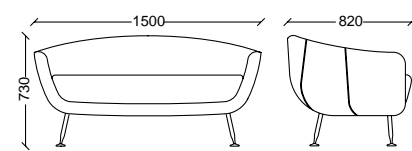

CM20

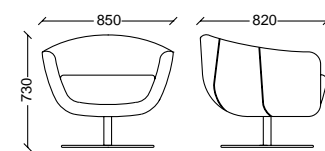

CM30



+ AGREE



AGREE

La serie Agree riesce a mettere tutti d'accordo grazie alla sua versatilità che permette di vivacizzare qualunque sala attesa.

The Agree series is in unison with all due to its versatility which enables it to bring any waiting room to life.



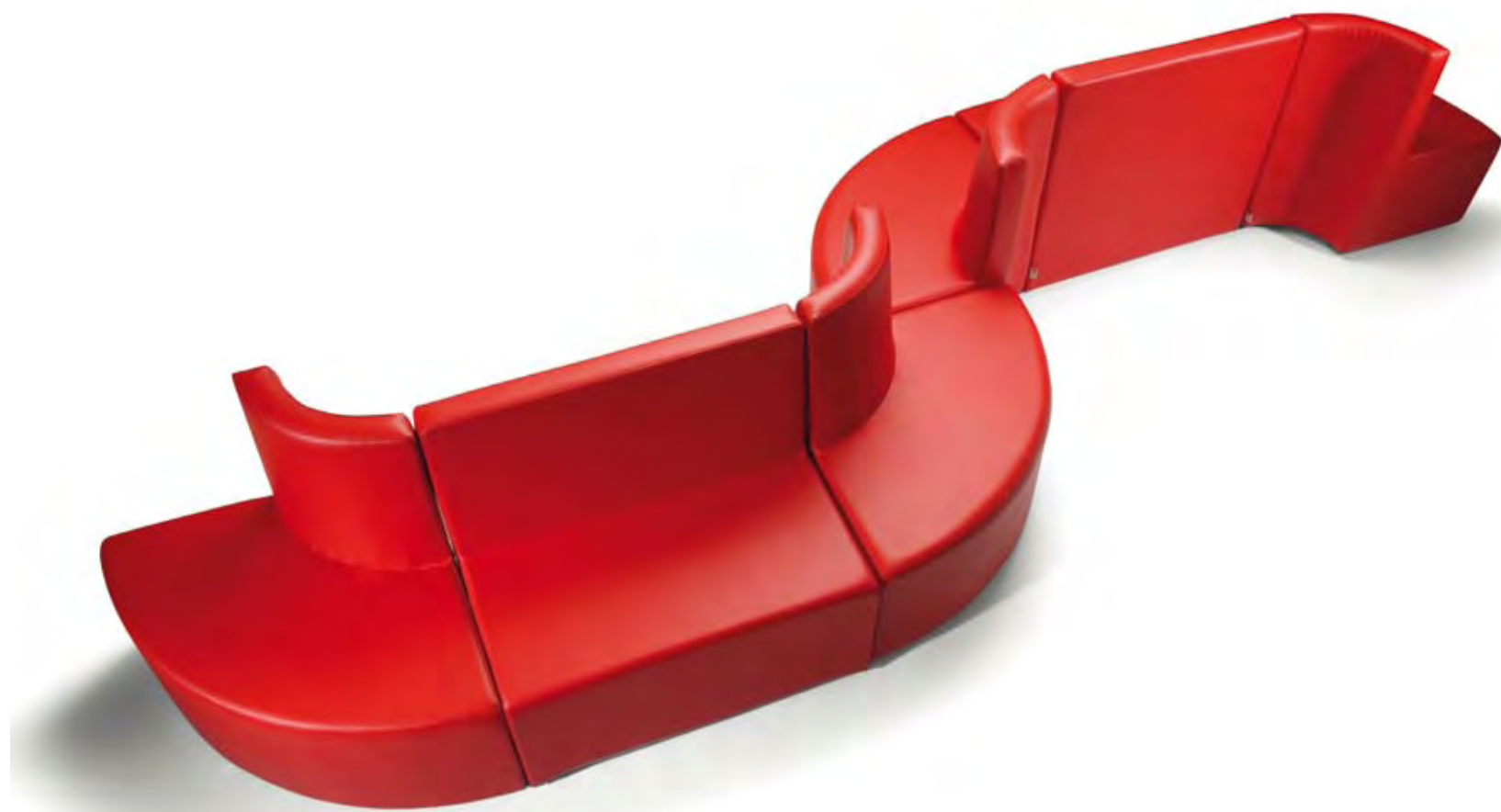

AGREE

Grazie alla serie Agree è così divertente creare il proprio design con tanti formati diversi per un ambiente speciale.

The Agree series makes it so fun to create your own design with so many shapes for a special environment.



A03



A01



A02



A04



A05

AGREE

1. Telaio interamente in multistrato di legno.
2. Sedile e schienale con cinghie elastiche fissate alla struttura.
3. Piedini in nylon a scomparsa.
4. in resine poliuretaniche ignifughe classe 1IM
5. Rivestimenti in base ns. cartella colori o tessuto cliente.

1. Frame in multilayered wood.
2. Seat and backrest with elastic straps fixed to the structure.
3. Hidden nylon feet.
4. Inner Upholstery in expanded flame retardant polyurethane class 1IM
5. Covering according to our fabric colour chart or by customer's fabrics.



A01



A02



A03



A04



A05



NOVITÀ - NEW

Personalizzazione cliente
Customer personalization

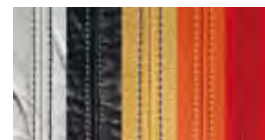

Possibilità di avere le cuciture di colore diverso dal rivestimento
Possibility to have different seam colour compared to upholstery

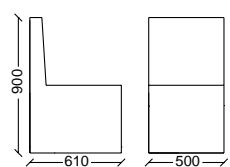

A01

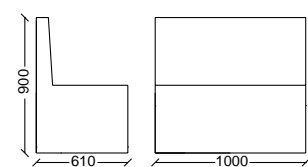

A02

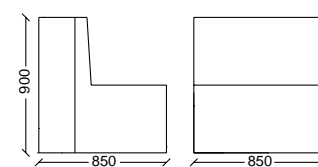

A03

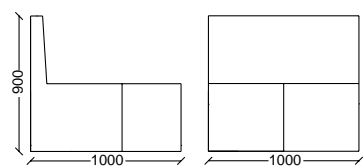

A04

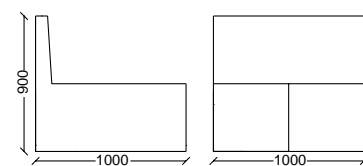

A05

+ TETRIS

TETRIS

La serie Tetris è una composizione di varie forme che possono essere collegate fra di loro.

The Tetris series is a composition of various shapes that can stand alone or be joined together.



TE01



TE02



TE03



TE04



TE05



TETRIS

Ogni formato della serie Tetris aggiunge particolarità al tuo ambiente.

It is really fun to create so many designs with the Tetris series pieces.



TE12



TE08



La serie Tetris rappresenta un insieme di forme e misure per completare le tue idee.

The Tetris series represents a group of shapes and sizes for you to complete your ideas.



TE06



TE07



TE10



TE08

TETRIS

1. Sagoma singolo o a due posti struttura in legno
 - con piedini in fibre di vetro cromati;
 - con piedini in nylon a scomparsa.
2. Imbottiture in resine poliuretaniche ignifughe classe 11M
3. Rivestimenti in base ns. cartella colori o tessuto cliente.

1. Frame single or two seater structure in wood
 - chromed fibre glass feet;
 - hidden nylon feet.
2. Inner Upholstery in expanded flame retardant polyurethane class 11M
3. Covering according to our fabric colour chart or by customer's fabrics.



TE01



TE02



TE03



TE04



TE05



TE06



TE07



TE08



TE10



TE12



NOVITÀ - NEW

Personalizzazione cliente
Customer personalization



Possibilità di avere le cuciture di colore diverso dal rivestimento
Possibility to have different seam colour compared to upholstery

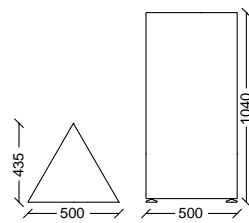

TE01

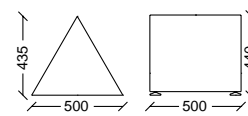

TE02

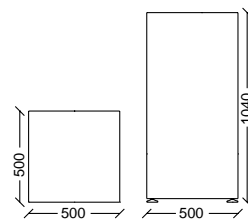

TE03

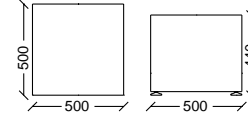

TE04

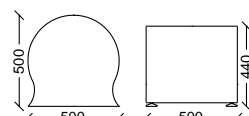

TE05



TE06

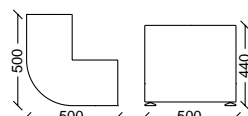

TE07

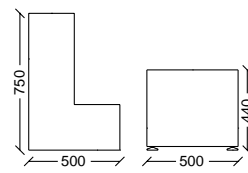

TE08

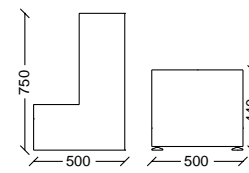

TE09

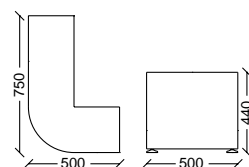

TE10

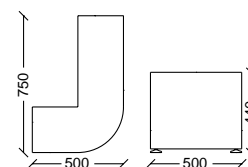

TE11

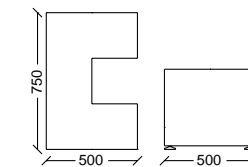

TE12



+ FORMAL

FORMAL

La serie Formal è una scelta raffinata che non tramonta mai.

The Formal series is a refined choice that will always be in style.



FR02



FR01



FR02



FR03

FORMAL

1. Telaio portante in profilo di acciaio sagomato e cromato.
2. Fianchi e braccioli in tondino di acciaio cromato diametro 16 mm.
3. Tavolo in laminato nero 280x540 mm spessore 18 mm (FR03).
4. Imbottiture in poliuretano schiumato a freddo con telaio interno in legno.
5. Rivestimenti in base ns. cartella colori o tessuto cliente.

1. Frame all bearing in chromed shape steel.
2. Flanks and armrests in solid chromed steel diameter 16 mm.
3. Table in black melaminic 280x540 mm, thickness 18 mm (FR03).
4. Imbottiture in cold foamed polyurethane with inner wooden frame.
5. Covering according to our fabric colour chart or by customer's fabrics.



NOVITÀ - NEW

Personalizzazione cliente
Customer personalization

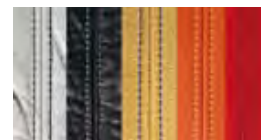

Possibilità di avere le cuciture di colore diverso dal rivestimento
Possibility to have different seam colour compared to upholstery

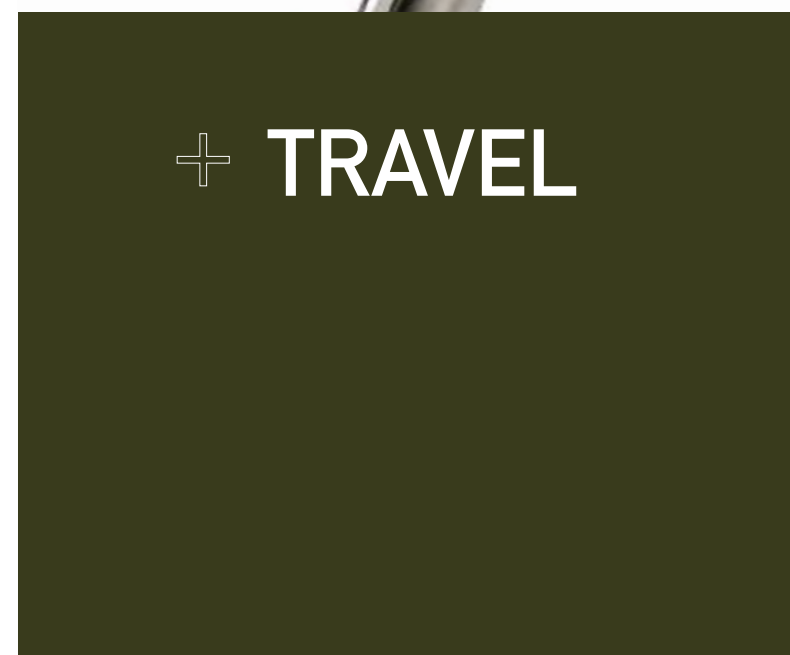
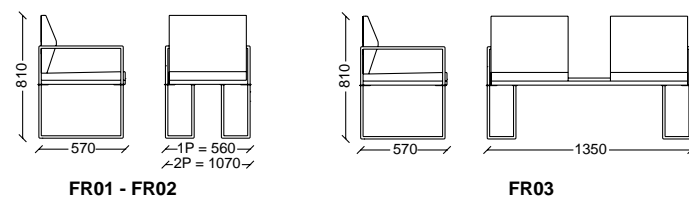

+ TRAVEL



TR11 CR

TRAVEL

La serie Travel è una creazione di puro design capace di illuminare l'ambiente più buio.

The Travel series is a creation of pure design and can enlighten the darkest environments.



TR03 CR



TR23 CR



TR12 CR



TRAVEL

La serie Travel versione panca con pannelli in Abs è un continuo sbizzarrirsi di colori vivaci.

The Travel series bench offers a lively colourful choice of Abs panels.



TR12 AL



TR23 AL



TR03 AL

TRAVEL

- Telaio:
 - in tubolare di acciaio cromato, sagomato diametro 35 mm, spessore 2,5 mm;
 - in tubolare di acciaio verniciato alluminio, sagomato diametro 35 mm, spessore 2,5 mm.
 - Piedini in alluminio con snodo per livellamento su pavimenti.
 - Scocche in ABS a vista, colori a scelta:
 - Bordeaux (BR)
 - Grigio (GR)
 - Arancio (AR)
 - Blu (BL)
 - Verde (VR)
 - Antracite (AN)
 - Braccioli in acciaio e poliuretano nero.
- Frame:
 - in chromed tubular shaped steel diameter 35 mm, thickness 2,5 mm.
 - in aluminium varnished tubular shaped steel diameter 35 mm, thickness 2,5 mm.
 - Feet in aluminium with joint for floor levelling.
 - Body in the following ABS colours:
 - Bordeaux (BR)
 - Grey (GR)
 - Orange (AR)
 - Blue (BL)
 - Green (VR)
 - Anthracite grey (AN)
 - Armrests in steel and black polyurethane.

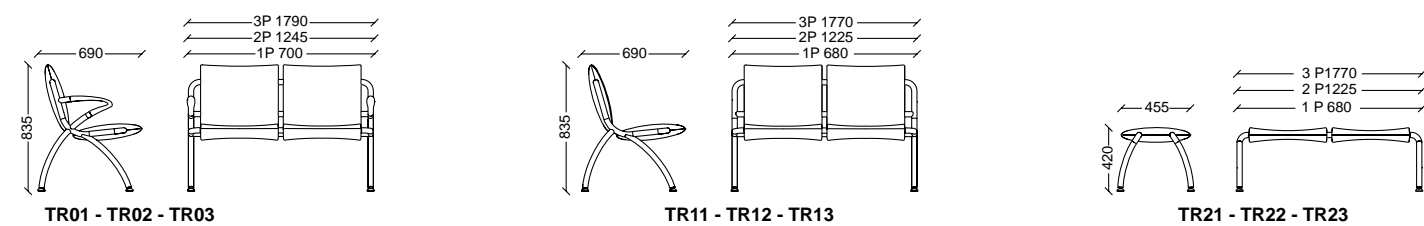

+ POINT



POINT

La serie Point con struttura in acciaio e scocca in lamiera forata con pannello rivestito è un cocktail vincente per aeroporti e non solo.

The Point series with steel structure and perforated sheet metal with upholstered panel is a winning cocktail for airports and not only.



P80



P81



P82+P90



P82



P84



P85+P91

POINT

La serie Point assume un altro aspetto quando viene rivestita totalmente evidenziando la sua linearità.

The Point series adopts another aspect when it is totally padded and upholstered showing its linearity.



P85



P83



POINT

La serie Point impressiona per la sua immagine metallica forte ma armoniosa nello stesso tempo.

The Point series is impressive for its strong metallic image but harmonious at the same time.



P86



P87



P88



P88-P92



POINT

1. Trave portante in acciaio verniciato nero 80x40 mm.
2. Gambe in acciaio sagomato cromato con piedini regolabili.
3. Braccioli in acciaio sagomato cromato.
4. Tavolo in laminato traforata verniciata grigia con bordo in acciaio cromato 450x540 mm.
5. Mono scocca:
 - in lamiera traforata verniciata grigia con bordo in acciaio cromato;
 - in faggio e pioppo curvato (versione rivestita).
6. Imbottitura in resine poliuretatiche ignifughe classe 11M.
7. Rivestimenti in base ns. cartella colori o tessuto cliente.

1. Crossbeam in black varnished steel 80x40 mm.
2. Legs in shaped chromed steel with adjustable feet.
3. Armrests in shaped chromed steel.
4. Table in open-work grey varnished sheet steel with chromed steel border 450x540 mm.
5. Shell body:
 - in open-work grey varnished sheet steel with chromed steel border;
 - in curved beech and poplar wood (upholstered version).
6. Inner Upholstery in expanded flame retardant polyurethane class 11M.
7. Covering according to our fabric colour chart or by customer's fabrics.



NOVITÀ - NEW
Personalizzazione cliente
Customer personalization

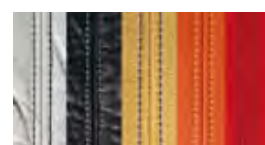

Possibilità di avere le cuciture di colore diverso dal rivestimento
Possibility to have different seam colour compared to upholstery

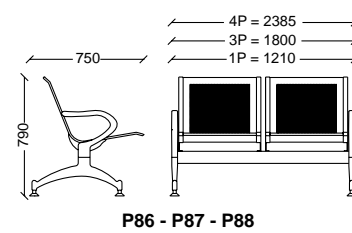
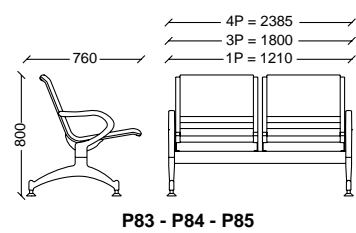
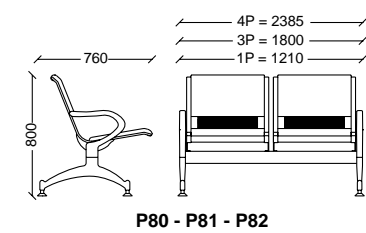

+ IGL00



IGLOO

La serie Igloo con o senza schienalino si presenta come prodotto ideale per sala riunioni.

The Igloo series, with or without backrest, is an ideal product for meeting rooms.



I90C

I90N

I90R

I91C

I91N

I91R





193C



193N

IGLOO

La serie Igloo con tavoletta scrittoio arricchisce questa poltrona candidandola come seduta perfetta per sala conference.

The writing board enriches the Igloo series chair and makes it the perfect choice for conference rooms.



192N



192C



IGLOO

1. Struttura interna in acciaio sagomato.
2. Piedini:
 - in poliamide nero,
 - in fibre di vetro cromati.
3. Ruote piroettanti a doppia battitura in nylon.
 - Opzionale gommate ed autofrenanti.
4. Tavoleta scrittoio in termoplastica nera con snodo antipanico in alluminio.
5. Imbottitura schiumato a freddo.
6. Rivestimenti in base ns. cartella colori o tessuto cliente.
7. Norme di riferimento
 - Poltrone e/o sedute visitatori En13761;
 - Poltrone e/o sedute collettività e contract En 15373;
 - Normative Uni vigenti.

1. Inner structure in shaped steel.
2. Feet:
 - in black polyamide;
 - in chromed fibre glass.
3. Wheel castors twin wheel nylon.
 - Optional rubber auto-braking.
4. Writing board in black thermal plastic with aluminium anti-panic joint.
5. Inner upholstery in cold foamed polyurethane.
6. Covering according to our fabric colour chart or by customer's fabrics.
7. Reference regulation
 - En13761 chair and/or visitor chair;
 - En15373 community and contract seat and/or chair;
 - Uni regulations.



I90C I90N I90R



I91C I91N I92C I92N I91R



I93C I93N



NOVITÀ - NEW

Personalizzazione cliente
Customer personalization



Possibilità di avere le cuciture di colore diverso dal rivestimento
Possibility to have different seam colour compared to upholstery

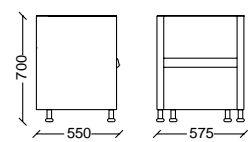

I90N - I90C

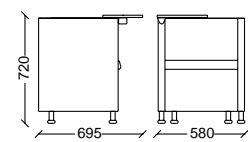

I93N - I93C

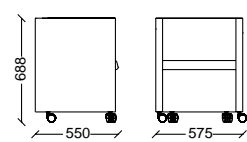

I90R

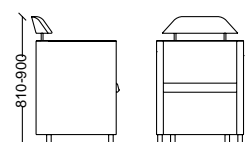

I91N - I91C

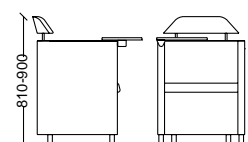

I92N - I92C

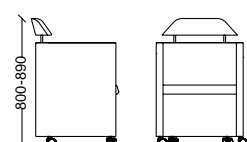

I91R



+ VIEW

VIEW



V60R

La serie View è una poltrona a pozzetto ricca di dettagli ed è capace di sposarsi bene con varie ambienti.

The View series is a tub chair with many details and is adaptable for various environments.



V60R

V60C

V61C

La serie View ha come caratteristica particolare un sedile ribaltabile che va aggiunta alla tavoletta scrittoio per confermare la sua completezza.

The View series features a particular bucket seat along with a writing board to confirm its completeness.



V60R

VIEW



V63C



V65C



La serie View al massimo della sua flessibilità, una poltrona totalmente pieghevole per ridurre gli spazi.

The View series is a true example of flexibility, a fully folding chair to reduce space.

La serie View si presenta nel suo modo più tradizionale con la possibilità di scelta fra ruote e piedini.

The View series presents itself in the most traditional manner with choice of wheels or feet.



V62R



V62C



V64C

VIEW

- Struttura interna in acciaio sagomato.
- pieghevole (V64C e V65C).
- Piedini:
- in poliamide nero;
- in fibre di vetro cromati.
- Ruote piroettanti a doppia battitura in nylon.
- Opzionale gommate ed autofrenanti.
- Sedile fisso o ribaltabile.
- Tavoletta scrittoio:
- in termoplastica nera con snodo antipanico in alluminio (V61C);
- in termoplastica nera con snodo antipanico in nylon nero (V63C, V65C).
- Imbottitura schiumato a freddo.
- Rivestimenti in base ns. cartella colori o tessuto cliente.
- Norme di riferimento
- Poltrone e/o sedute visitatori En 13761;
- Poltrone e/o sedute collettività e contract En 15373;
- Normative Uni vigenti.

- Inner structure in shaped steel.
- foldable (V64C e V65C).
- Feet:
- in black polyamide;
- in chromed fibre glass.
- Wheel castors twin wheel nylon.
- Optional rubber auto-braking.
- Seat fixed or bucket.
- Writing board:
- in black thermal plastic with aluminium anti-panic joint (V61C);
- in black thermal plastic with black nylon anti-panic joint (V63C, V65C).
- Inner upholstery in cold foamed polyurethane.
- Covering according to our fabric colour chart or by customer's fabrics.
- Reference regulation
- En 13761 chair and/or visitor chair;
- En 15373 community and contract seat and/or chair;
- Uni regulations.



V60R



V60C



V61C



V62R



V62C



V63C



V64C



V65C



NOVITÀ - NEW

Personalizzazione cliente
Customer personalization

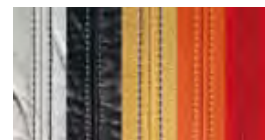

Possibilità di avere le cuciture di colore diverso dal rivestimento
Possibility to have different seam colour compared to upholstery

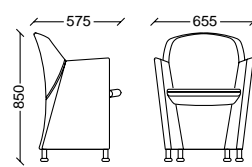

V60C

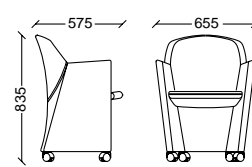

V60R

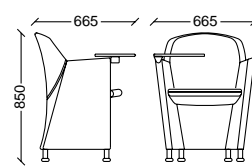

V61C

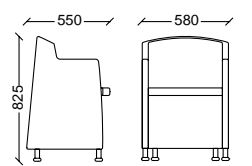

V62C

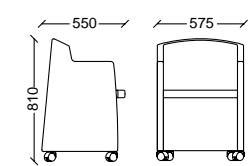

V62R

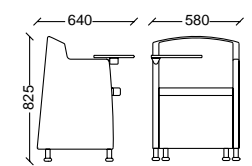

V63C - V65C

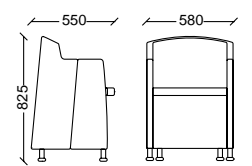

V64C



+ CORNER

CORNER

La serie Corner è un mix di prodotti di qualità sicuro di aggiungere quel tocco in più al tuo ambiente preferito.

The Corner series is a mix of quality products sure to add that extra touch to your favorite environments.



CR59



CR58



CR55

CR56

CR54

La serie Corner in varie versioni con base a scelta.

The Corner series in many versions with choice of bases.



CR52



CR35



CORNER

La serie Corner per l'operatore o il visitatore non cambia nella sua eleganza.

The Corner series for the operator or the visitor does not change in its elegance.



CR34



CR33



CR31



CR30



CR32

CORNER

- Base:
 - 5 razze in nylon nero caricato con fibre di vetro (CR30, CR33);
 - 5 razze in acciaio cromato (CR31, CR34, CR52);
 - 4 razze fissa in acciaio cromato (CR32, CR35, CR56);
 - 4 razze girevole in acciaio cromato (CR);
 - zavorrata tonda in acciaio cromato spessore 10 mm (CR54);
 - zavorrata quadra in acciaio cromato, spessore 10 mm (CR55).
- Alzo a gas regolabile in altezza (CR30, CR31, CR33, CR34, CR52).
- Movimento auto allineante (CR54, CR55).
- Imbottitura schiumato a freddo.
- Braccioli:
 - incorporati nella scocca (CR52, CR54, CR55, CR56);
 - in poliuretano nero (CR30, CR31, CR32);
 - in acciaio cromato (CR33, CR34, CR35).
- Rivestimenti in base ns. cartella colori o tessuto cliente.
- Norme di riferimento
 - Poltrone e/o sedute visitatori En13761;
 - Poltrone e/o sedute collettività e contract En 15373;
 - Normative Uni vigenti.

- Base:
 - 5 star black nylon with reinforced fibre glass. (CR30, CR33);
 - 5 star chromed steel (CR31, CR34, CR52);
 - 4 star fixed chromed steel (CR32, CR35, CR56);
 - 4 star swivel chromed steel (CR);
 - flat rounded ballast chromed steel, thickness 10 mm (CR54);
 - squared ballast chromed steel, thickness 10 mm (CR55).
- Gas lift height adjustable (CR30, CR31, CR33, CR34, CR52).
- Movement auto aligning (CR54, CR55).
- Inner upholstery in cold foamed polyurethane.
- Armrests:
 - incorporated in the body (CR52, CR54, CR55, CR56);
 - in black polyurethane (CR30, CR31, CR32);
 - in chromed steel (CR33, CR34, CR35).
- Covering according to our fabric colour chart or by customer's fabrics.
- Reference regulation
 - En13761 chair and/or visitor chair;
 - En15373 community and contract seat and/or chair;
 - Uni regulations.

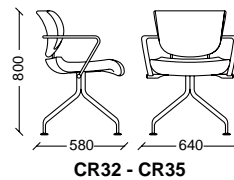
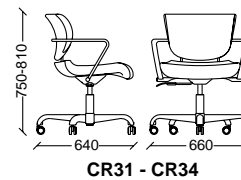
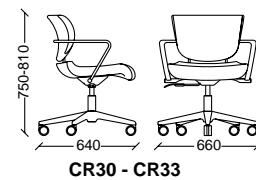
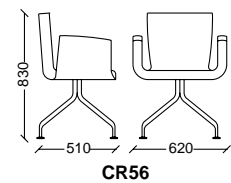
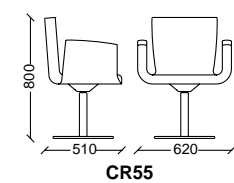
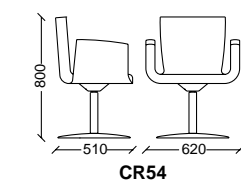
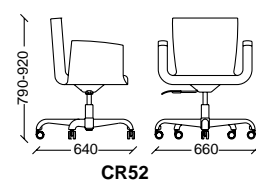
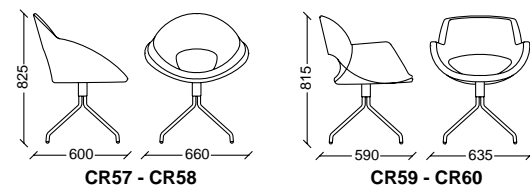

NOVITÀ - NEW

Personalizzazione cliente
Customer personalization

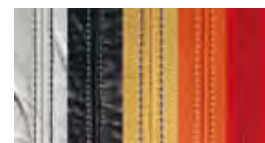

Possibilità di avere le cuciture di colore diverso dal rivestimento
Possibility to have different seam colour compared to upholstery





+ FLEX



FLEX

La serie Flex coinvolge il visitatore grazie alla sua linearità, design, stabilità e comodità.

The Flex series involves the visitor due to its linearity, design, stability and comfort.



FX88 TR



FX85 TR



FX88 NR



FX85 NR

FLEX

- Telaio:**
 - a slitta in tubolare di acciaio cromato diametro 22 mm con braccioli incorporati;
 - a 4 gambe in tubolare di acciaio cromato diametro 22 mm con braccioli incorporati.
- Schienale:**
 - in nylon nero;
 - in policarbonato trasparente neutro.
- Sedile rivestito con interno in acciaio e copertura sotto sedile in nylon nero.**
- Imbottitura schiumata a freddo.**
- Rivestimenti in base ns. cartella colori o tessuto cliente.**
- Norme di riferimento**
 - Poltrone e/o sedute visitatori En 13761;
 - Poltrone e/o sedute collettività e contract En 15373;
 - Normative Uni vigenti.

- Frame:**
 - tubular chromed steel cantilever frame diameter 22 mm with incorporated armrests;
 - tubular chromed steel four leg frame diameter 22 mm with incorporated armrests.
- Backrest:**
 - in black nylon;
 - in neutral transparent polycarbonate.
- Seat upholstered with inner steel support and black nylon under seat cover.**
- Inner upholstery in cold foamed polyurethane.**
- Covering according to our fabric colour chart or by customer's fabrics.**
- Reference regulation**
 - En 13761 chair and/or visitor chair;
 - En 15373 community and contract seat and/or chair;
 - Uni regulations.



NOVITÀ - NEW

Personalizzazione cliente
Customer personalization

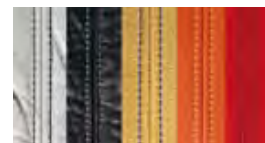

Possibilità di avere le cuciture di colore diverso dal rivestimento
Possibility to have different seam colour compared to upholstery

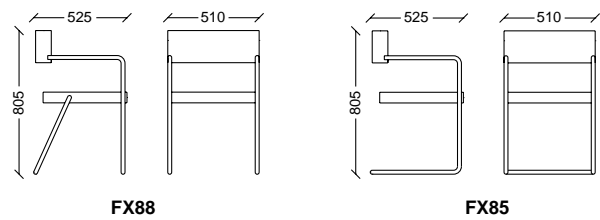

UTILIZZI / USERS

La vasta gamma di sedie collettività prodotte dalla Seipo Srl offre tutte le appropriate e possibili soluzioni per vivacizzare ed valorizzare qualsiasi ambiente da arredare: contract, sale mense, wine bar fino ai ristoranti, ufficio, sala conferenza, auditorium, scuole e o aule universitarie. I prodotti offerti garantiscono un ampio ventaglio di colori, design, comodità e polifunzionalità ove è necessario.

Seipo srl produces a vast range of community chairs which allow for appropriate and possible solutions to brighten up and enhance any environment in need of furnishing: contract, lunchrooms, wine bars, restaurants, offices, conference halls, auditoriums, schools and or lecture halls. The offered products guarantee a broad choice of colours, designs, comfort and multifunctionality where it is needed.



SALA CONFERENZA
MEETING ROOM



SALA ATTESA
WAITING ROOM



TAVOLO RIUNIONE
MEETING TABLE



VISITATORE
VISITOR CHAIR



+ FLY



FY01

La serie Fly rappresenta la scelta ideale per qualsiasi evenienza.

The Fly series is the ideal choice for any event.



FLY

La serie Fly è impilabile sia in verticale che in orizzontale grazie alla sua seduta ribaltabile.

The Fly series is horizontally and vertically stackable thanks to its folding seat.



FY02



FY02



FY03



FY01+FY07

FLY

La serie Fly totalmente imbottita con copertina per lo schienale in poliuretano oppure con schienale in rete.

The Fly series can be fully padded and upholstered with polyurethane backrest or with net backrest.



FY08



FY04



FY05



FY05



FY06



FLY

1. Telaio in tubolare di acciaio cromato a sezione tonda 22 mm e tappi antiscivolo alle estremità.
2. Schienale:
 - in nylon nero;
 - in rete con cornice in nylon nera;
 - copertina schienale imbottita e rivestita.
3. Sedile ribaltabile con interno in acciaio annegato nel nylon, sottosedile in nylon nero.
4. Braccioli fissi in nylon nero con staffa in acciaio cromato.
5. Gancio di allineamento in nylon nero.
6. Tavoleta scrittoio in termoplastica nera con snodo antipanico in alluminio.
7. Segna posti per sedie fisse.
8. Imbottiture in resine poliuretatiche ignifughe classe 11M.
9. Rivestimenti in base ns. cartella colori o tessuto cliente.
10. Norme di riferimento
 - poltrone e/o sedute visitatori En 13761;
 - poltrone e/o sedute collettive e contract En 15373;
 - normative Uni vigenti;
 - solo a richiesta omologazione classe 11M con tessuto Categoria L con sovrapprezzo del 10%.

1. Frame in tubular chromed steel with round section 22 mm and nonslip caps on the extremities.
2. Backrest:
 - in black nylon;
 - in net with black nylon frame;
 - padded and upholstered cover.
3. Bucket seat upholstered made of inner steel with nylon covering and black nylon underseat.
4. Armrests in fixed black nylon with chromed steel support.
5. Hook alignment in black nylon.
6. Writing board in black thermal plastic with aluminium anti-panic joint.
7. Seat indicator for fixed chairs.
8. Inner Upholstery in expanded flame retardant polyurethane class 11M
9. Covering according to our fabric colour chart or by customer's fabrics.
10. Reference regulation
 - En 13761 chair and/or visitor chair;
 - En 15373 community and contract seat and/or chair;
 - Uni regulations;
 - Only on approval request, 11M class with category L fabric cost an extra 10%.



FY07
Copertina schienale
Backrest cover



FY08
Gancio di allineamento
Alignment hook



FY09
Segnaposti o segnafile
Placeholder or row indicator



NOVITÀ - NEW

Personalizzazione cliente
Customer personalization

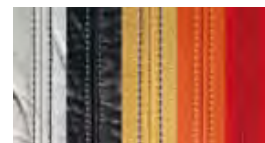

Possibilità di avere le cuciture di colore diverso dal rivestimento
Possibility to have different seam colour compared to upholstery

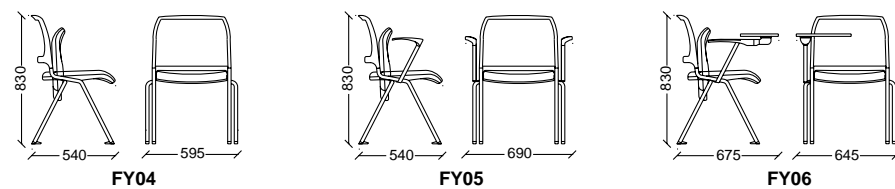
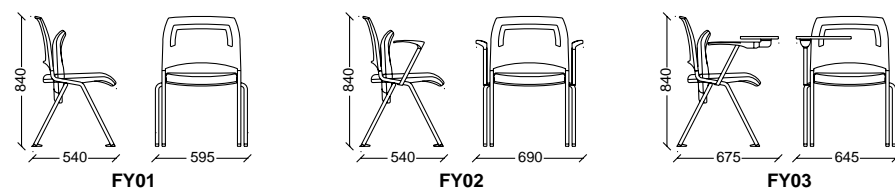

UTILIZZI / USERS

La vasta gamma di sedie collettive prodotte dalla Seipo Srl offre tutte le appropriate e possibili soluzioni per vivacizzare ed valorizzare qualsiasi ambiente da arredare: contract, sale mense, wine bar fino ai ristoranti, ufficio, sala conferenza, auditorium, scuole e o aule universitarie. I prodotti offerti garantiscono un ampio ventaglio di colori, design, comodità e polifunzionalità ove è necessario.

Seipo srl produces a vast range of community chairs which allow for appropriate and possible solutions to brighten up and enhance any environment in need of furnishing: contract, lunchrooms, wine bars, restaurants, offices, conference halls, auditoriums, schools and or lecture halls. The offered products guarantee a broad choice of colours, designs, comfort and multifunctionality where it is needed.



SALA CONFERENZA
MEETING ROOM



SALA ATTESA
WAITING ROOM



TAVOLO RIUNIONE
MEETING TABLE



VISITATORE
VISITOR CHAIR



+ FLAG

FLAG



FL37 AZ



FL57



FL35 BL



FL35 AZ



FL35 BN



FL35 SB



FL35 BR



FL35 NR



FL35 GR



FL37 BL



FL37 AZ



FL37 BN



FL37 SB



FL37 BR



FL37 NR



FL37 GR



FLAG

La serie Flag offre modelli in polipropilene di vari colori, imbottiti e rivestiti per intero o con schienale in rete.

The Flag series offers many models in various polypropylene colours, full padded and upholstered or with a net backrest.



FL65 NR



FL56



FL65 BN



FL63 BN

FLAG

La serie Flag per i suoi tanti abbinamenti rende questa seduta eclettica e piacevole.

The Flag series is eclectic and enjoyable for its many combinations.



FL45 BN



FL47 BN



FL53 BN



FL55 BN



FLAG

- Telaio a 4 gambe in acciaio cromato diametro 22 mm.
- Sedile:
 - imbottito con interno in nylon e sotto sedile in polipropilene nei vari colori;
 - in polipropilene nei vari colori.
- Schienale:
 - imbottito con interno in nylon e dietro schienale in polipropilene nei vari colori;
 - in rete con cornice a vista in polipropilene nei vari colori;
 - in polipropilene nei vari colori.
- Braccioli fissi in nylon colorato.
- Gancio di allineamento in filo d'acciaio.
- Carrello porta sedie in acciaio dotato di ruote.
- Imbottiture in resine poliuretatiche ignifughe classe 11M.
- Rivestimenti in base ns. cartella colori o tessuto cliente.
- Norme di riferimento
 - Poltrone e/o sedute visitatori En 13761;
 - Poltrone e/o sedute collettività e contract En 15373;
 - Normative Uni vigenti;
 - Solo a richiesta omologazione classe 11M con tessuto Categoria L con sovrapprezzo del 10%.

- Frame tubular 4 leg chromed steel diameter 22 mm.
- Seat:
 - upholstered with inner nylon seat and nylon under seat in various colours to choose from (upholstered version);
 - in various polypropylene colours to choose from (polypropylene version).
- Backrest:
 - upholstered with inner nylon backrest and nylon outer backrest in various colours to choose from (upholstered version);
 - in net with polypropylene frame to choose in various colours (net version);
 - in various polypropylene colours to choose from (polypropylene version).
- Armrests in fixed coloured nylon.
- Hook alignment in wiry chromed steel.
- Chair trolley in steel with castors.
- Inner Upholstery in expanded flame retardant polyurethane class 11M
- Covering according to our fabric colour chart or by customer's fabrics.
- Reference regulation
 - En 13761 chair and/or visitor chair
 - En 15373 community and contract seat and/or chair
 - Uni regulations
 - Only on approval request, 11M class with category L fabric cost an extra 10%.



FL35 FL37 FL63 FL65

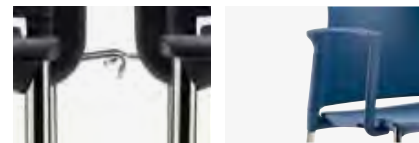

FL56
Gancio di allineamento
Alignment hook

Bracciolo in polipropilene
Polypropylene armrest



FL45 FL47 FL53 FL55



FL57
Carrello portasedie
Chair trolley



NOVITÀ - NEW

Personalizzazione cliente
Customer personalization

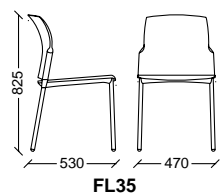

FL35

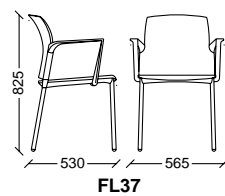

FL37

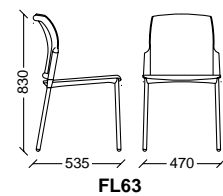

FL63

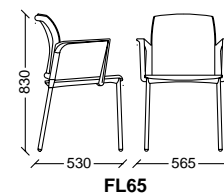

FL65

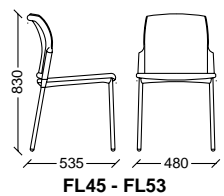

FL45 - FL53

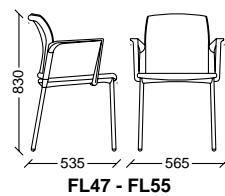

FL47 - FL55

UTILIZZI / USERS

La vasta gamma di sedie collettività prodotte dalla Seipo Srl offre tutte le appropriate e possibili soluzioni per vivacizzare ed valorizzare qualsiasi ambiente da arredare: contract, sale mense, wine bar fino ai ristoranti, ufficio, sala conferenza, auditorium, scuole e o aule universitarie. I prodotti offerti garantiscono un ampio ventaglio di colori, design, comodità e polifunzionalità ove è necessario.

Seipo srl produces a vast range of community chairs which allow for appropriate and possible solutions to brighten up and enhance any environment in need of furnishing: contract, lunchrooms, wine bars, restaurants, offices, conference halls, auditoriums, schools and or lecture halls. The offered products guarantee a broad choice of colours, designs, comfort and multifunctionality where it is needed.



SALA CONFERENZA
MEETING ROOM



SALA ATTESA
WAITING ROOM



TAVOLO RIUNIONE
MEETING TABLE



VISITATORE
VISITOR CHAIR



+ CRONO

CRONO

La serie Crono è un capolavoro di design e colori che rendono vivace il vostro ambiente.

The Crono series is a masterpiece of design and colour and brings life to your environment.



C153



C140 FC



C141 FC



C141 FC



C140 VR

C140 BN

C140 TR

C140 BL

C140 NR

C140 MR

C140 RS



C141 VR

C141 BN

C141 TR

C141 BL

C141 NR

C141 MR

C141 RS



C142 VR

C142 BN

C142 TR

C142 BL

C142 NR

C142 MR

C142 RS



CRONO

La serie Crono è comoda e divertente
la si può facilmente adattare a qualsiasi
ambiente.

*The Crono series is comfortable, enjoyable
and adaptable to any environment.*



C142 FC



C143 FC



C143 VR

C143 BN

C143 TR

C143 BL

C143 NR

C143 MR

C143 RS



C144 VR



C144 BN



C144 TR



C144 BL



C144 NR



C144 MR



C144 RS



C144 FC



CRONO

La serie Crono è girevole ed è disponibile anche la versione sgabello per godersi un momento di relax.

The Crono series is swivel and also available in the stool version for relaxing enjoyable moments.



C146 VR



C145 RS



C152 BL



C149 RS

CRONO

- Telaio:
 - a slitta in filo d'acciaio cromato.
 - a 4 gambe in acciaio cromato tubolare diametro 22 mm;
- Base a 5 razze in alluminio pressofuso spazzolato e lucidato.
- Ruote piroettanti a doppia battitura gommata diametro 50 mm.
- Alzo a gas tramite pompa a gas.
- Movimento piastra a gas (A) con leva per il comando della regolazione in altezza.
- Monoscocca in polipropilene nei vari colori.
- Braccioli fissi in filo d'acciaio cromato con pad in nylon colorato.
- Sgabelli con telaio in filo d'acciaio cromato.
- Panche:
 - da 2 a 4 posti con travi e gambe in acciaio verniciato bianco;
 - da 2 a 4 posti con travi e gambe in acciaio verniciato grigio.
- Carrello porta sedie in acciaio dotato di ruote.
- Norme di riferimento
 - Poltrone e/o sedute visitatori En 13761;
 - Poltrone e/o sedute collettive e contract En 15373;
 - Normative Uni vigenti.

- Frame:
 - wiry chromed steel cantilever chair;
 - tubular 4 leg chromed steel diameter 22 mm.
- Five star base in polished die cast aluminium.
- Wheel castors twin rubber diameter 50 mm.
- Gas lift.
- Movement Gas plate (A) with lever to regulate chair height.
- Shell body in various polypropylene colours.
- Armrests in fixed wiry chromed steel with coloured nylon pad.
- Stools in wiry chromed steel frame.
- Bench seating:
 - from 2 to 4 seaters with beam and legs in white varnished steel;
 - from 2 to 4 seaters with beam and legs in aluminium varnished steel.
- Chair trolley in steel with castors.
- Reference regulation
 - En 13761 chair and/or visitor chair;
 - En 15373 community and contract seat and/or chair;
 - Uni regulations

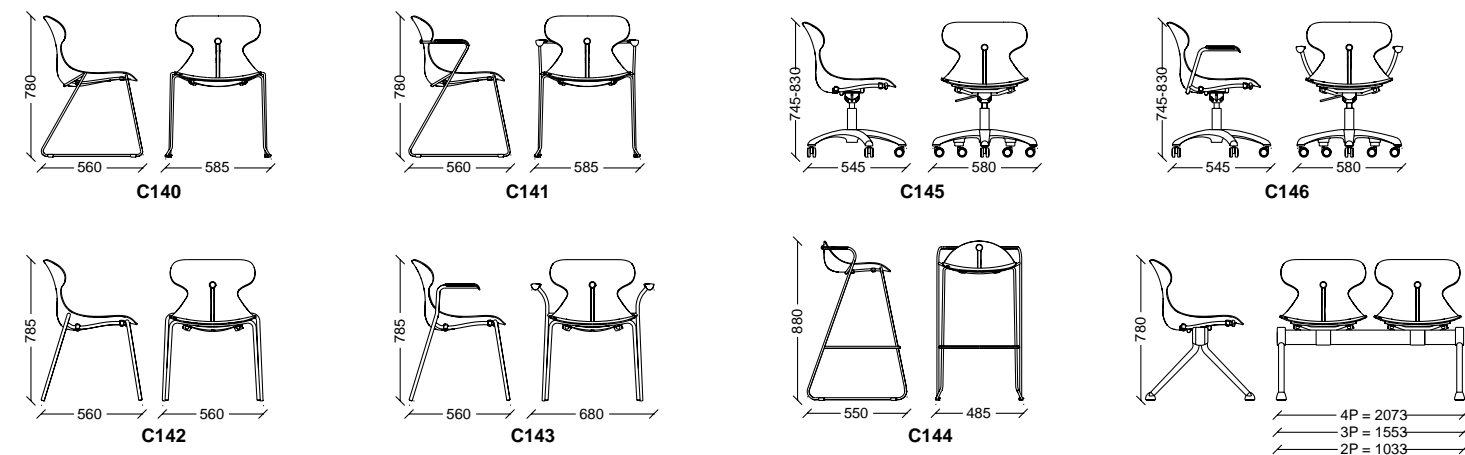

C147 - C148 - C149
C150 - C151 - C152

UTILIZZI / USERS

La vasta gamma di sedie collettive prodotte dalla Seipo Srl offre tutte le appropriate e possibili soluzioni per vivacizzare ed valorizzare qualsiasi ambiente da arredare: contract, sale mense, wine bar fino ai ristoranti, ufficio, sala conferenza, auditorium, scuole e o aule universitarie. I prodotti offerti garantiscono un ampio ventaglio di colori, design, comodità e polifunzionalità ove è necessario.

Seipo srl produces a vast range of community chairs which allow for appropriate and possible solutions to brighten up and enhance any environment in need of furnishing: contract, lunchrooms, wine bars, restaurants, offices, conference halls, auditoriums, schools and or lecture halls. The offered products guarantee a broad choice of colours, designs, comfort and multifunctionality where it is needed.



SALA CONFERENZA
MEETING ROOM



SALA ATTESA
WAITING ROOM



TAVOLO RIUNIONE
MEETING TABLE



VISITATORE
VISITOR CHAIR



+ STEP

STEP

La serie Step è una linea importante per la famiglia contract, un incrocio di colori e di facile collocazione.

The Step series is an important chair for the contract family. It is a mix of colours and fits in easily.



St 39 N



St 25 N



St 36 A



St 31 A



St 32 A



St 35 B



St 36 B



St 37 B



St 38 B



St 41 C

STEP

VERSIONE POLIPROPILENE

1. telaio:
 - a) 4 gambe e a slitta in acciaio diametro 22 mm.
 - verniciato grigio alluminio (A)
 - verniciato bianco (B)
 - cromato (C)
 - verniciato nero (N)
 - b) 4 gambe in acciaio diametro 22 mm su ruote.
 - verniciato grigio alluminio (A)
 - cromato (C)
 - verniciato nero (N)
2. Sedile in polipropilene nei colori:
 - grigio (Gr) - nero (NR) - bianco (BN).
3. Schienale in polipropilene nei vari colori:
 - grigio (Gr) - nero (NR) - bianco (BN).
4. Schienale versione rete cornice schienale in polipropilene colori:
 - grigio (Gr) - nero(NR).
5. Snodo metallico antipanico con tavoletta in termoplastica nei colori grigio e nero.
6. Gancio di allineamento in acciaio verniciato nero.
7. rivestimento dello schienale in rete in base alla ns. cartella colori categoria R.
8. Norme di riferimento
 - Poltrone e/o sedute visitatori En 13761
 - Poltrone e/o sedute collettività e contract En 15373

POLYPROPYLENE VERSION

1. Frames:
 - a) chromed steel 4 leg and cantilever versions diameter 22 mm.
 - varnished aluminium (A)
 - varnished white (B)
 - chromed (C)
 - varnished black (n)
 - b) chromed steel 4 leg diameter 22 mm on castors.
 - varnished aluminium (A)
 - chromed (C)
 - varnished black (n)
2. Seat: in various polypropylene colours:
 - grey (GR) - black (NR) - white (BN).
3. Backrest in various polypropylene colours:
 - grey (GR) - black (NR) - white(BN).
4. net backrest: frame in various polypropylene colours:
 - grey (GR) - black (NR).
5. Writing board in grey or black thermal plastic with metallic anti-panic joint.
6. Hook alignment in black varnished steel.
7. Covering according to our fabric colour chart or by customer's fabrics
8. Reference regulation
 - En 13761 chair and/or visitor chair
 - En 15373 community and contract seat and/or chair
 - Uni regulations



St 25N St 26N St 27N St 28N St 29N St 39N



tavoletta nera con snodo antipanico
Black writing board with panic joint



Bracciolo in nylon nero
Black nylon armrest



St 30A St 31A St 32A St 33A St 34A St 40A



tavoletta grigia con snodo antipanico
Grey writing board with panic joint



Bracciolo in nylon grigio
Grey nylon armrest



St 35B St 36B St 37B St 38B St 41C



Bracciolo in nylon bianco
White nylon armrest

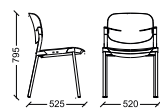

ST25-ST30-ST35

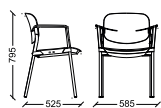

ST26-ST31-ST36

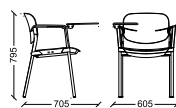

ST27-ST32

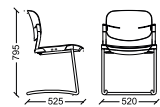

ST28-ST33-ST37



ST29-ST34-ST38

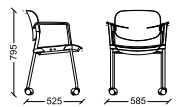

ST39-ST40-ST41



Carrello portasedie
Chair trolley



Gancio di allineamento
Alignment hook

UTILIZZI / USERS

La vasta gamma di sedie collettività prodotte dalla Seipo srl offre tutte le appropriate e possibili soluzioni per vivacizzare ed valorizzare qualsiasi ambiente da arredare: contract, sale mense, wine bar fino ai ristoranti, ufficio, sala conferenza, auditorium, scuole e o aule universitarie. I prodotti offerti garantiscono un ampio ventaglio di colori, design, comodità e polifunzionalità ove è necessario.

Seipo srl produces a vast range of community chairs which allow for appropriate and possible solutions to brighten up and enhance any environment in need of furnishing: contract, lunchrooms, wine bars, restaurants, offices, conference halls, auditoriums, schools and or lecture halls. The offered products guarantee a broad choice of colours, designs, comfort and multifunctionality where it is needed.



SALA CONFERENZA
MEETING ROOM



SALA ATTESA
WAITING ROOM



TAVOLO RIUNIONE
MEETING TABLE



VISITATORE
VISITOR CHAIR

STEP

La serie Step è disponibile nella versione slitta o quattro gambe con tavoletta scrittoio colorato.

The Step series is available with a cantilever or 4 leg base and coloured writing board.



ST65A



ST67A



ST68A



ST24A



ST66A



ST69A



ST66N

La serie Step su ruote viaggia a pari passo con i tempi, pratico ed efficace.

The Step series on wheels is convenient and efficient, it goes hand in hand with time.



ST60N



ST61N



ST62N



ST63N



ST64N



ST23N

STEP

VERSIONE POLIPROPILENE - RETE

- Telaio:
 - 4 gambe e a slitta in acciaio diametro 22 mm.
 - verniciato grigio alluminio (A)
 - verniciato bianco (B)
 - cromato (C)
 - verniciato nero (N)
 - 4 gambe in acciaio diametro 22 mm su ruote.
 - verniciato grigio alluminio (A)
 - cromato (C)
 - verniciato nero (N)
- Sedile in polipropilene nei colori: grigio (GR) - nero (NR) - bianco (BN).
- Schienale in polipropilene nei vari colori: grigio (GR) - nero (NR) - bianco (BN).
- Schienale versione rete cornice schienale in polipropilene colori: grigio (GR) - nero (NR).
- Snodo metallico antipanico con tavoletta in termoplastica nei colori grigio e nero.
- Gancio di allineamento in acciaio verniciato nero.
- Rivestimento dello schienale in rete in base alla ns. cartella colori categoria R.
- Norme di riferimento
 - Poltrone e/o sedute visitatori En 13761
 - Poltrone e/o sedute collettività e contract En 15373

POLYPROPYLENE SEAT AND NET BACKEREST VERSION

- Frames:
 - chromed steel 4 leg and cantilever versions diameter 22 mm.
 - varnished aluminium (A)
 - varnished white (B)
 - chromed (C)
 - varnished black (N)
 - chromed steel 4 leg diameter 22 mm on castors.
 - varnished aluminium (A)
 - chromed (C)
 - varnished black (N)
- Seat: in various polypropylene colours: grey (GR) - black (NR) - white (BN).
- Backrest in various polypropylene colours: grey (GR) - black (NR) - white (BN).
- Net backrest: frame in various polypropylene colours: grey (GR) - black (NR).
- Writing board in grey or black thermal plastic with metallic anti-panic joint.
- Hook alignment in black varnished steel.
- Covering according to our fabric colour chart or by customer's fabrics
- Reference regulation
 - En 13761 chair and/or visitor chair
 - En 15373 community and contract seat and/or chair
 - Uni regulations



Tavoletta nera con snodo antipanico
Black writing board with panic joint
Bracciolo in nylon nero
Black nylon armrest



Tavoletta grigia con snodo antipanico
Grey writing board with panic joint
Bracciolo in nylon grigio
Grey nylon armrest

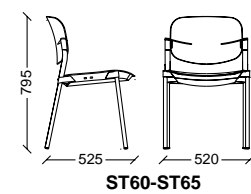

ST60-ST65

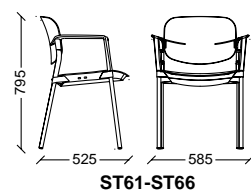

ST61-ST66

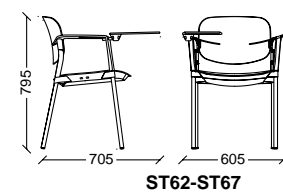

ST62-ST67

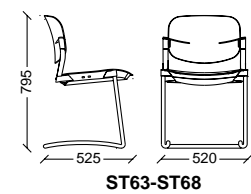

ST63-ST68

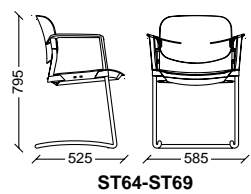

ST64-ST69

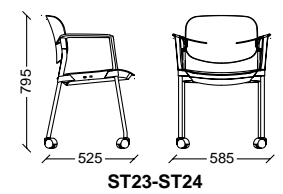

ST23-ST24



Carrello portasedie
Chair trolley



Gancio di allineamento
Alignment hook

UTILIZZI / USERS

La vasta gamma di sedie collettività prodotte dalla Seipo Srl offre tutte le appropriate e possibili soluzioni per vivacizzare ed valorizzare qualsiasi ambiente da arredare: contract, sale mense, wine bar fino ai ristoranti, ufficio, sala conferenza, auditorium, scuole e o aule universitarie. I prodotti offerti garantiscono un ampio ventaglio di colori, design, comodità e polifunzionalità ove è necessario.

Seipo srl produces a vast range of community chairs which allow for appropriate and possible solutions to brighten up and enhance any environment in need of furnishing: contract, lunchrooms, wine bars, restaurants, offices, conference halls, auditoriums, schools and or lecture halls. The offered products guarantee a broad choice of colours, designs, comfort and multifunctionality where it is needed.



SALA CONFERENZA
MEETING ROOM



SALA ATTESA
WAITING ROOM



TAVOLO RIUNIONE
MEETING TABLE



VISITATORE
VISITOR CHAIR



ST49A



ST53B



ST54B



ST56C



ST57A

STEP

La serie Step è disponibile con telaio e colore di polipropilene a scelta, con o senza braccioli.

The Step series is available with frame and polypropylene colours to choose from, with or without armrests.

La serie Step offre talmente tante possibilità di combinazioni che rende la vostra scelta divertente.

The Step series offers so many possible combinations that it makes choosing fun.



ST45C



ST55C



ST50C



ST42N



ST43N



ST44N



ST56N



ST45N



ST46N

STEP

VERSIONE IMBOTTITA

- Telaio a
 - 4 gambe e a slitta in acciaio diametro 22 mm.
 - verniciato grigio alluminio (A)
 - verniciato bianco (B)
 - cromato (C)
 - verniciato nero (N)
 - 4 gambe in acciaio diametro 22 mm su ruote.
 - verniciato grigio alluminio (A)
 - cromato (C)
 - verniciato nero (N)
- Sedile con interno in polipropilene.
- Schienale con interno in polipropilene.
- Schienale versione rete cornice schienale in polipropilene colori: grigio (GR) - nero (NR).
- Braccioli in polipropilene nei vari colori: grigio (GR) - nero (NR) - bianco (BN).
- Snodo metallico antipanico con tavoletta in termoplastica nei colori grigio e nero.
- Gancio di allineamento in acciaio verniciato nero.
- Imbottiture in resine poliuretatiche ignifughe classe 1IM
- Rivestimenti in base ns. cartella colori o tessuto cliente.
- Norme di riferimento
 - Poltrone e/o sedute visitatori En 13761
 - Poltrone e/o sedute collettività e contract En 15373
 - Normative Uni vigenti
 - Solo a richiesta omologazione classe 1IM con tessuto Categoria L con sovrapprezzo del 10%

UPHOLSTERY VERSION

- Frames:
 - in chromed steel 4 leg and cantilever versions diameter 22 mm.
 - varnished aluminium (A)
 - varnished white (B)
 - chromed (C)
 - varnished black (N)
 - in chromed steel 4 leg diameter 22 mm on castors.
 - varnished aluminium (A)
 - chromed (C)
 - varnished black (N)
- Seat made of inner polypropylene.
- Backrest made of inner polypropylene.
- Net backrest: frame in various polypropylene colours: grey (GR) - black (NR).
- Armrests in various polypropylene colours: grey (GR) - black (NR) - white (BN).
- Writing board in grey or black thermal plastic with metallic anti-panic joint.
- Hook alignment in black varnished steel.
- Inner Upholstery in expanded flame retardant polyurethane class 1IM
- Covering according to our fabric colour chart or by customer's fabrics.
- Reference regulation
 - En 13761 chair and/or visitor chair
 - En 15373 community and contract seat and/or chair
 - Uni regulations
 - Only on approval request, 1IM class with category L fabric cost an extra 10%.



NOVITÀ - NEW

Personalizzazione cliente
Customer personalization

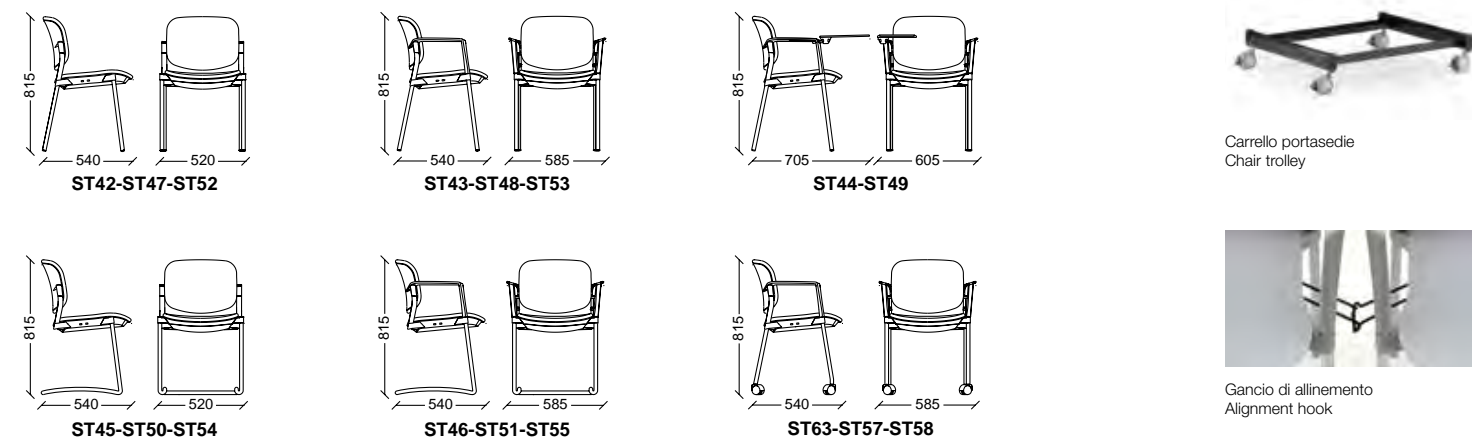

UTILIZZI / USERS

La vasta gamma di sedie collettività prodotte dalla Seipo Srl offre tutte le appropriate e possibili soluzioni per vivacizzare ed valorizzare qualsiasi ambiente da arredare: contract, sale mense, wine bar fino ai ristoranti, ufficio, sala conferenza, auditorium, scuole e o aule universitarie. I prodotti offerti garantiscono un ampio ventaglio di colori, design, comodità e polifunzionalità ove è necessario.

Seipo srl produces a vast range of community chairs which allow for appropriate and possible solutions to brighten up and enhance any environment in need of furnishing: contract, lunchrooms, wine bars, restaurants, offices, conference halls, auditoriums, schools and or lecture halls. The offered products guarantee a broad choice of colours, designs, comfort and multifunctionality where it is needed.



SALA CONFERENZA
MEETING ROOM



SALA ATTESA
WAITING ROOM



TAVOLO RIUNIONE
MEETING TABLE



VISITATORE
VISITOR CHAIR

STEP

La serie Step con schienale in rete, seduta imbottita e rivestita spicca in qualunque ambiente.

The Step series with a net backrest, padded and upholstered seat stands out in any environment.



ST78A



ST78C



ST75C



ST76N



ST77A



ST79C



ST80A



ST81A



ST71A



ST72N



ST73N



ST74N



ST75N



ST70N

STEP

VERSIONE IMBOTTITA - RETE

- Telaio a
 - 4 gambe e a slitta in acciaio diametro 22 mm.
 - verniciato grigio alluminio (A)
 - verniciato bianco (B)
 - cromato (C)
 - verniciato nero (N)
 - 4 gambe in acciaio diametro 22 mm su ruote.
 - verniciato grigio alluminio (A)
 - cromato (C)
 - verniciato nero (N)
- Sedile con interno in polipropilene.
- Schienale con interno in polipropilene.
- Schienale versione rete cornice schienale in polipropilene colori: grigio (GR) - nero (NR).
- Braccioli in polipropilene nei vari colori: grigio (GR) - nero (NR) - bianco (BN).
- Snodo metallico antipanico con tavoletta in termoplastica nei colori grigio e nero.
- Gancio di allineamento in acciaio verniciato nero.
- Imbottiture in resine poliuretatiche ignifughe classe 1IM
- Rivestimenti in base ns. cartella colori o tessuto cliente.
- Norme di riferimento
 - Poltrone e/o sedute visitatori En13761
 - Poltrone e/o sedute collettività e contract En 15373
 - Normative Uni vigenti
 - Solo a richiesta omologazione classe 1IM con tessuto Categoria L con sovrapprezzo del 10%

UPHOLSTERED SEAT AND NET BACKREST VERSION

- Frames:
 - in chromed steel 4 leg and cantilever versions diameter 22 mm.
 - varnished aluminium (A)
 - varnished white (B)
 - chromed (C)
 - varnished black (N)
 - in chromed steel 4 leg diameter 22 mm on castors.
 - varnished aluminium (A)
 - chromed (C)
 - varnished black (N)
- Seat made of inner polypropylene.
- Backrest made of inner polypropylene.
- Net backrest: frame in various polypropylene colours: grey (GR) - black (NR).
- Armrests in various polypropylene colours: grey (GR) - black (NR) - white (BN).
- Writing board in grey or black thermal plastic with metallic anti-panic joint.
 - Hook alignment in black varnished steel.
 - Inner Upholstery in expanded flame retardant polyurethane class 1IM
 - Covering according to our fabric colour chart or by customer's fabrics.
- Reference regulation
 - En13761 chair and/or visitor chair
 - En15373 community and contract seat and/or chair
 - Uni regulations
 - Only on approval request, 1IM class with category L fabric cost an extra 10%.



Tavoletta nera con snodo antipanico
Black writing board with panic joint
Bracciolo in nylon nero
Black nylon armrest



Tavoletta grigia con snodo antipanico
Grey writing board with panic joint
Bracciolo in nylon grigio
Grey nylon armrest

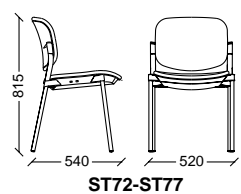

ST72-ST77

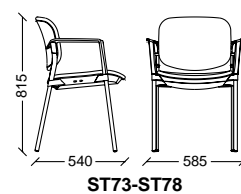

ST73-ST78

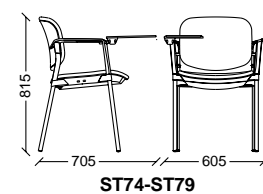

ST74-ST79

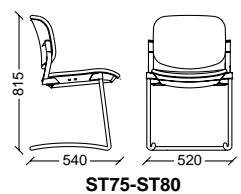

ST75-ST80

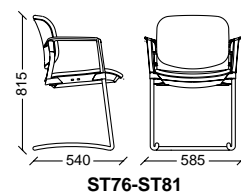

ST76-ST81

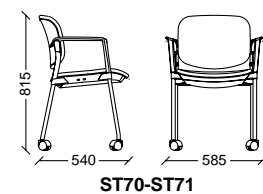

ST70-ST71



Carrello portasedie
Chair trolley



Gancio di allineamento
Alignment hook

UTILIZZI / USERS

La vasta gamma di sedie collettività prodotte dalla Seipo Srl offre tutte le appropriate e possibili soluzioni per vivacizzare ed valorizzare qualsiasi ambiente da arredare: contract, sale mense, wine bar fino ai ristoranti, ufficio, sala conferenza, auditorium, scuole e o aule universitarie. I prodotti offerti garantiscono un ampio ventaglio di colori, design, comodità e polifunzionalità ove è necessario.

Seipo srl produces a vast range of community chairs which allow for appropriate and possible solutions to brighten up and enhance any environment in need of furnishing: contract, lunchrooms, wine bars, restaurants, offices, conference halls, auditoriums, schools and or lecture halls. The offered products guarantee a broad choice of colours, designs, comfort and multifunctionality where it is needed.



SALA CONFERENZA
MEETING ROOM



SALA ATTESA
WAITING ROOM



TAVOLO RIUNIONE
MEETING TABLE

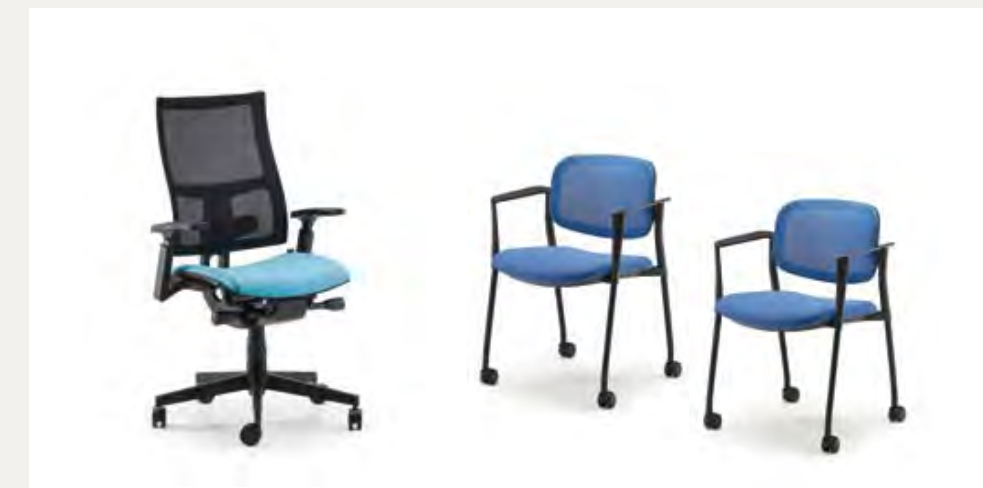

VISITATORE
VISITOR CHAIR



+ TARGET



T200B

T201B

T200C

T201A

T201N



TARGET

La serie Target si può presentare in versione acciaio cromato o verniciato nero con i braccioli che richiamano il telaio e la possibilità di aggiungere la tavoletta scrittoio.

The Target series may be chromed or black varnished steel with an armrest that recalls the frame and the possibility to add a writing board.



T200C



T203N

T204N

T200N



T192A



T154N + T176



T164A



T174N

TARGET

La serie Target esprime pienamente la sua adattabilità nella versione panca.

The Target series fully expresses its adaptability in the bench version.



T182B



T192B



T154B

TARGET SEDIE E PANCHE MOBILI - CHAIRS AND MOBILE BENCHES

- Telaio a 4 gambe in acciaio cromato tubolare diametro 22 mm;
 - 4 gambe e a slitta in acciaio diametro 22 mm.
 - verniciato grigio alluminio (A)
 - verniciato bianco (B)
 - cromato (C)
 - verniciato nero (N)
 - 4 gambe in acciaio diametro 22 mm su ruote.
 - verniciato grigio alluminio (A)
 - cromato (C)
 - verniciato nero (N)
- Sedile rivestito in multistrato di faggio e pioppo curvato.
- Schienale rivestito in multistrato di faggio e pioppo curvato.
- Braccioli:
 - fissi in filo d'acciaio verniciato nero con pad in nylon nero;
 - fissi in filo d'acciaio cromato con pad in nylon nero;
 - terminale per panche ribaltabile;
 - in alluminio (versione panca fissa).
- Tavoletta scrittoio in termoplastica nera con snodo antipanico.
- Panche:
 - da 2 a 5 posti fissi con telaio in acciaio verniciato alluminio;
 - da 2 a 5 posti fissi con telaio in acciaio verniciato bianco;
 - da 2 a 5 posti fissi con telaio in acciaio verniciato nero.
- Gancio di allineamento:
 - gancio corto in plastica nera per sedute senza braccioli;
 - gancio lungo in acciaio verniciato nero per sedute con braccioli.
- Cestello portariviste in filo d'acciaio verniciato nero.
- Carrello porta sedie in acciaio dotato di ruote.
- Imbottiture in resine poliuretaniche ignifughe classe 1M.
- Rivestimenti in base ns. cartella colori o tessuto cliente.
- Norme di riferimento:
 - Poltrone e/o sedute visitatori En 13761;
 - Poltrone e/o sedute collettività e contract En 15373;
 - Normative Uni vigenti;
 - Solo a richiesta omologazione classe 1M con tessuto Categoria L con sovrapprezzo del 10%.

- Frame tubular 4 leg chromed steel diameter 22 mm;
 - in chromed steel 4 leg and cantilever versions diameter 22 mm.
 - varnished aluminium (A)
 - varnished white (B)
 - chromed (C)
 - varnished black (N)
 - in chromed steel 4 leg diameter 22 mm on castors.
 - varnished aluminium (A)
 - chromed (C)
 - varnished black (N)
- Seat made of curved beech and poplar wood in multiple layers.
- Backrest made of curved beech and poplar wood in multiple layers.
- Armrests:
 - in fixed wiry black varnished steel with black nylon pad;
 - in fixed wiry chromed steel with black nylon pad;
 - terminal for benches with foldable seats;
 - in aluminium (fixed bench version).
- Writing board in black thermal plastic with anti-panic joint.
- Bench seating:
 - from 2 to 5 fixed seats with aluminium varnished steel frame;
 - from 2 to 5 fixed seats with white varnished steel frame;
 - from 2 to 5 fixed seats with black varnished steel frame.
- Hook alignments:
 - short hook in black plastic for chairs without armrests;
 - long hook in black varnished steel for chairs with armrests.
- Basket in wiry black varnished steel.
- Chair trolley in steel with castors.
- Inner Upholstery in expanded flame retardant polyurethane class 1M.
- Covering according to our fabric colour chart or by customer's fabrics.
- Reference regulation:
 - En 13761 chair and/or visitor chair;
 - En 15373 community and contract seat and/or chair;
 - Uni regulations;
 - Only on approval request, 1M class with category L fabric cost an extra 10%.



Tavoletta nera con snodo antipanico
Black writing board with panic joint
Bracciolo in acciaio cromato con pad nylon
Steel chromed armrest with nylon pad



Struttura panca verniciata nera
Black varnished bench structure
Bracciolo in acciaio verniciato nero con pad nylon
Black varnished steel armrest with nylon pad



Struttura panca verniciata grigia
Grey varnished bench structure
Bracciolo in acciaio verniciato alluminio con pad nylon
Aluminium varnished steel armrest with nylon pad



Struttura panca verniciata bianca
White varnished bench structure
Bracciolo in acciaio verniciato bianco con pad nylon
White varnished steel armrest with nylon pad



Gancio di allineamento lungo
Long alignment hook
Gancio di allineamento corto
Short alignment hook
Cestello portariviste
Magazine basket
Carrello portasedie
Chair trolley
Tavolo al posto della seduta
Table instead of seat
Gamba in alluminio
Aluminium leg
Bracciolo in alluminio lucido
Polished aluminium armrest

UTILIZZI / USERS

La vasta gamma di sedie collettività prodotte dalla Seipo Srl offre tutte le appropriate e possibili soluzioni per vivacizzare ed valorizzare qualsiasi ambiente da arredare: contract, sale mense, wine bar fino ai ristoranti, ufficio, sala conferenza, auditorium, scuole e o aule universitarie. I prodotti offerti garantiscono un ampio ventaglio di colori, design, comodità e polifunzionalità ove è necessario.

Seipo srl produces a vast range of community chairs which allow for appropriate and possible solutions to brighten up and enhance any environment in need of furnishing: contract, lunchrooms, wine bars, restaurants, offices, conference halls, auditoriums, schools and or lecture halls. The offered products guarantee a broad choice of colours, designs, comfort and multifunctionality where it is needed.



SALA CONFERENZA
MEETING ROOM



SALA ATTESA
WAITING ROOM



VISITATORE
VISITOR CHAIR

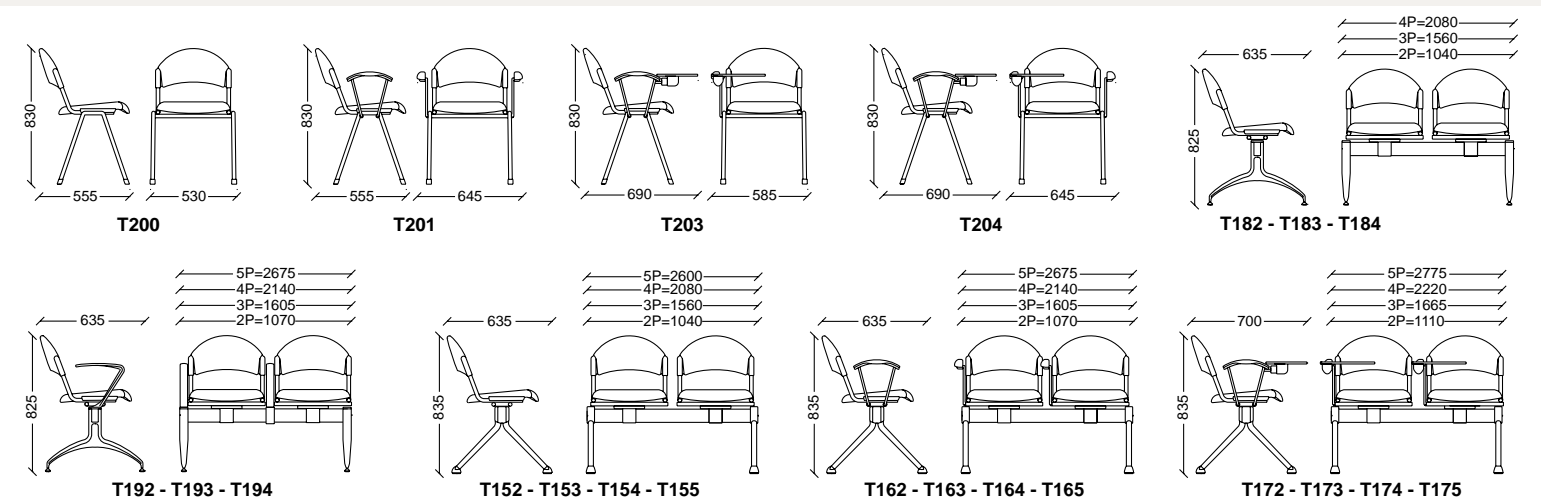

TARGET

La serie Target versione panca ribaltabile è composta da una robusta struttura portante ed accessori a scelta. È un prodotto ideale per ambienti dove è necessario avere tanta qualità in poco spazio.

The Target series bench with flip up seats is made of a robust all bearing structure with many accessories to choose from. It is an ideal product for settings where lots of quality is needed in small spaces.



T213N



T222N + T237



T232N + T237



T252N + T258



T242N + T258



T212N

T252N + T258



TARGET PANCA RIBALTABILE E TAVOLI SCUOLA - BUCKET SEAT BENCHES AND SCHOOL DESKS

- Telaio in acciaio nero tubolare diametro 22 mm.
- Sedile rivestito in multistrato di faggio e pioppo curvato.
- Schienale rivestito in multistrato di faggio e pioppo curvato.
- Braccioli:
 - fissi in filo d'acciaio nero con pad in nylon nero;
 - terminale in filo d'acciaio nero con pad in nylon nero per panca ribaltabile.
- Tavoletta scrittoio in termoplastica nera con snodo antipanico.
- Panche:
 - da 2 a 5 posti ribaltabile con telaio in acciaio verniciato alluminio;
 - da 2 a 5 posti ribaltabile con telaio in acciaio verniciato bianco;
 - da 2 a 5 posti ribaltabile con telaio in acciaio verniciato nero.
- Cestello sottopiano per il banco.
- Banco:
 - da 2 a 5 posti con piano fisso melaminico bordato in abs e struttura in acciaio verniciata nera;
 - da 2 a 5 posti con piano ribaltabile melaminico bordato in abs e struttura in acciaio verniciata nera.
- Modesty panel verniciato.
- Imbottiture in resine poliuretaniche ignifughe classe 1IM.
- Rivestimenti in base ns. cartella colori o tessuto cliente.
- Norme di riferimento
 - Poltrone e/o sedute visitatori En 12727;
 - Solo a richiesta omologazione classe 1IM con tessuto Categoria L con sovrapprezzo del 10%.

- Frame tubular 4 leg chromed steel diameter 22 mm.
- Seat made of curved beech and poplar wood in multiple layers.
- Backrest made of curved beech and poplar wood in multiple layers.
- Armrests:
 - in fixed wiry chromed steel with coloured nylon pad;
 - terminal for benches with foldable seats.
- Writing board in black thermal plastic with anti-panic joint.
- Bench seating:
 - from 2 to 5 bucket seats with aluminium varnished steel frame.
 - from 2 to 5 bucket seats with white varnished steel frame.
 - from 2 to 5 bucket seats with black varnished steel frame.
- Basket under the desk.
- School desk:
 - from 2 to 5 places with melamine fixed top, abs bordering and black varnished steel structure.
 - from 2 to 5 places with melamine foldable top, abs bordering and black varnished steel structure.
- Modesty panel varnished.
- Covering according to our fabric colour chart or by customer's fabrics.
- Inner Upholstery in expanded flame retardant polyurethane class 1IM
- Reference regulation
 - En 12727 Fixed to the floor bench;
 - Only on approval request, 1IM class with category L fabric cost an extra 10%.w



NOVITÀ - NEW
Personalizzazione cliente
Customer personalization



Tavoletta nera con snodo antipanico
Black writing board with panic joint



Gamba fissaggio a pavimento
Leg fixed to the floor



Modesty panel

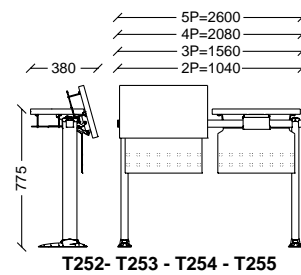
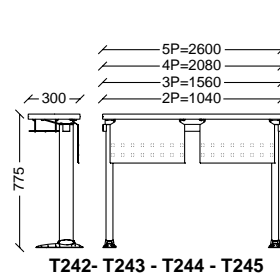
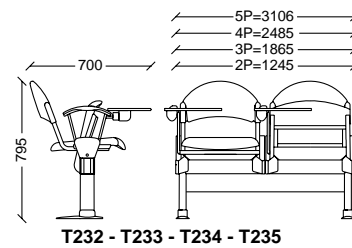
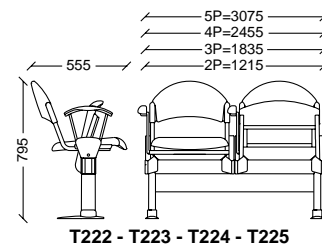
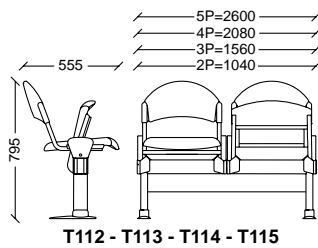

UTILIZZI / USERS

La vasta gamma di sedie collettività prodotte dalla Seipo Srl offre tutte le appropriate e possibili soluzioni per vivacizzare ed valorizzare qualsiasi ambiente da arredare: contract, sale mense, wine bar fino ai ristoranti, ufficio, sala conferenza, auditorium, scuole e o aule universitarie. I prodotti offerti garantiscono un ampio ventaglio di colori, design, comodità e polifunzionalità ove è necessario.

Seipo srl produces a vast range of community chairs which allow for appropriate and possible solutions to brighten up and enhance any environment in need of furnishing: contract, lunchrooms, wine bars, restaurants, offices, conference halls, auditoriums, schools and or lecture halls. The offered products guarantee a broad choice of colours, designs, comfort and multifunctionality where it is needed.



SALA CONFERENZA
MEETING ROOM



SALA UNIVERSITARIA
UNIVERSITY ROOM



+ CONCORDIA

EUROPA

La serie Europa si distingue per il suo design e comodità.

The Europa series distinguishes itself for its design and comfort.

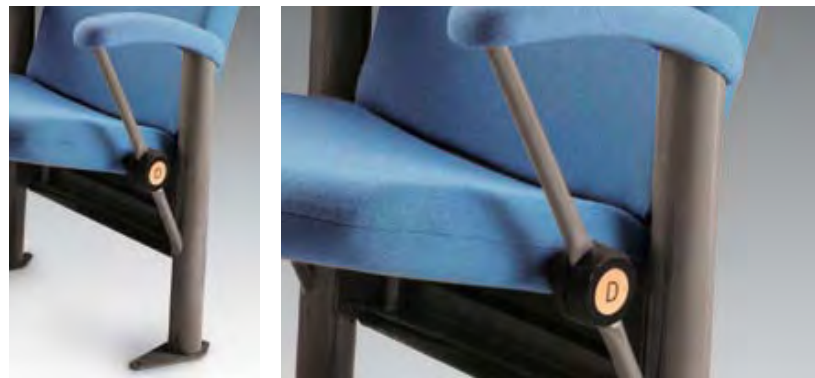

CONCORDIA

La serie Concordia irrompe con la sua vasta scelta di poltrone di sicuro comodità e facile installazione.

The Concordia series bursts on the scene with its wide range of comfortable chairs which allow for easy installation.



CONCORDIA

La serie Concordia con le sue innumerevoli forme esprime l'imbarazzo della scelta.

The numerous types of the Concordia series allow for the right choice.



CONCORDIA

La serie Concordia con forma quadrata, scelta di bracciolo e tavoletta scrittoio non passa inosservata.

The square shaped Concordia series with choice of armrest and writing board cannot be unnoticed.



CONCORDIA

La serie Concordia con tavoletta scrittoio incorporato da la possibilità del logo personalizzato e di aggiungere il segnaposto o segnafila.

The Concordia series is also available with an incorporated writing board. Personalized logos, row indicators or placeholders are important details.



EUROPA

1. Trave di unione per fianchi in acciaio verniciato a polveri epossidiche sezione 80x40cm.
2. Sedile con interno in acciaio interamente schiumato a freddo con molle di ritorno automatico e sistema di ribaltamento per gravità (contrappeso).
- rivestimento con cucitura centrale sedile.
3. Schienale con interno in acciaio interamente schiumato a freddo con innesto a baionetta.
- rivestimento con cucitura centrale schienale.
4. Dietro schienale:
- carter in lamiera di acciaio verniciato.
5. Logo cliente, segna fila e segna posto cucito con filato a scelta del cliente.
6. Braccioli:
- in tubolare di acciaio con pad rivestito.
7. Rivestimenti in base ns. cartella colori o tessuto cliente.
8. Norme di riferimento
- Poltrone e/o sedute visitatori En 12727;
- Solo a richiesta omologazione classe 11M con tessuto Categoria V con sovrapprezzo del 10%.
1. *Crossbeam for grouped flanks in steel shore painted epoxy technique section 80x40cm.*
2. *Seat made of inner steel and entirely cold foamed with automatic spring return and gravity turnover system (counter-weight).
- upholstered with central stitching on seat (rounded version).*
3. *Backrest made of inner steel and entirely cold foamed with bayonet insertion.
- upholstered with central stitching on backrest (rounded version).*
4. *Backrest cover:
- black varnished sheet steel carter;
- varnished wooden carter.*
5. *Customer's logo, row and seat indicators stiched within the fabric upon customer's choice.*
6. *Armrests:
- Black varnished with upolstery armrest pad.*
7. *Covering according to our fabric colour chart or by customer's fabrics.*
8. *Reference regulation
- En 12727 Fixed to the floor bench
- Only on approval request, 11M class with category V fabric cost an extra 10%.*

CONCORDIA

POLTRONA CON FIANCO FISSO A PAVIMENTO

1. Trave di unione per fianchi in acciaio verniciato a polveri epossidiche sezione 80x40cm.
2. Sedile con interno in acciaio interamente schiumato a freddo con molle di ritorno automatico e sistema di ribaltamento per gravità (contrappeso).
- rivestimento con cucitura nei bordi perimetrali con doppia impuntura (versione squadrata);
- rivestimento con cucitura centrale sedile (versione arrotondata).
3. Schienale con interno in acciaio interamente schiumato a freddo con innesto a baionetta.
- rivestimento con cucitura nei bordi perimetrali con doppia impuntura (versione squadrata);
- rivestimento con cucitura centrale schienale (versione arrotondata).
4. Dietro schienale:
- carter in lamiera di acciaio verniciato;
- carter in legno verniciato.
5. Logo cliente, segna fila e segna posto cucito con filato a scelta del cliente.
6. Braccioli:
- interamente schiumato a freddo;
- tavoletta incorporata con struttura in acciaio con pannelli rivestiti.
7. Pad bracciolo:
- pad rivestito;
- pad in poliuretano nero;
- pad in legno verniciato.
8. Tavoletta scrittoio in HPL con snodo antipanico.
9. Rivestimenti in base ns. cartella colori o tessuto cliente.
10. Norme di riferimento:
- Poltrone e/o sedute visitatori En 12727;
- Solo a richiesta omologazione classe 11M con tessuto Categoria L con sovrapprezzo del 10%

BENCH SEATING WITH FIXED FLANK TO THE FLOOR

1. *Crossbeam for grouped flanks in steel shore painted epoxy technique section 80x40cm.*
2. *Seat made of inner steel and entirely cold foamed with automatic spring return and gravity turnover system (counter-weight).
- upholstered with double stitching on perimeters (squared version);
- upholstered with central stitching on seat (rounded version).*
3. *Backrest made of inner steel and entirely cold foamed with bayonet insertion.
- upholstered with double stitching on perimeters (squared version);
- upholstered with central stitching on backrest (rounded version).*
4. *Backrest cover:
- black varnished sheet steel carter;
- varnished wooden carter.*
5. *Customer's logo, row and seat indicators stiched within the fabric upon customer's choice.*
6. *Armrests:
- entirely cold foamed.
- incorporated writing board with steel structure and upholstered panel.*
7. *Pad:
- upholstered pad;
- black polyurethane pad;
- varnished wooden pad.*
8. *Writing board in HPL with anti-panic joint.*
9. *Covering according to our fabric colour chart or by customer's fabrics.*
10. *Reference regulation:
- En 12727 Fixed to the floor bench
- Only on approval request, 11M class with category L fabric cost an extra 10%.*

EUROPA

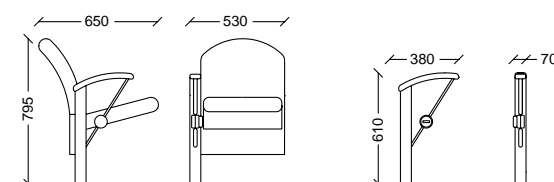

NOVITÀ - NEW

Personalizzazione cliente
Customer personalization

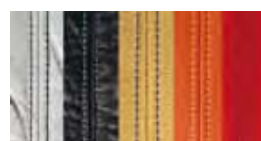

Possibilità di avere le cuciture di colore diverso dal rivestimento
Possibility to have different seam colour compared to upholstery

CONCORDIA

PANCHE CON GAMBE MOBILI E CON FISSAGGIO A PAVIMENTO

1. Trave in acciaio verniciato a polveri epossidiche sezione 80x40cm per gambe mobili e con fissaggio a pavimento.
2. Sedile con interno in acciaio interamente schiumato a freddo con molle di ritorno automatico e sistema di ribaltamento per gravità (contrappeso).
- rivestimento con cucitura nei bordi perimetrali con doppia impuntura (versione squadrata);
- rivestimento con cucitura centrale sedile (versione arrotondata).
3. Schienale con interno in acciaio interamente schiumato a freddo con innesto a baionetta.
- rivestimento con cucitura nei bordi perimetrali con doppia impuntura (versione squadrata);
- rivestimento con cucitura centrale schienale (versione arrotondata).
4. Dietroschienale:
- rivestito;
- carter in lamiera di acciaio verniciato;
- carter in legno verniciato.
5. Logo cliente, segna fila e segna posto cucito con filato a scelta del cliente.
6. Braccioli:
- interamente schiumato a freddo;
- tavoletta incorporata con struttura in acciaio con pannelli rivestiti.
7. Pad bracciolo:
- pad rivestito;
- pad in poliuretano nero;
- pad in legno verniciato.
8. Tavoletta scrittoio in HPL con snodo antipanico.
9. Rivestimenti in base ns. cartella colori o tessuto cliente.
10. Norme di riferimento:
- Poltrone e/o sedute visitatori En 12727;
- Solo a richiesta omologazione classe 11M con tessuto Categoria L con sovrapprezzo del 10%.

BENCH SEATING WITH MOVABLE AND AND FIXED LEG TO THE FLOOR

1. *Crossbeam in steel shore painted epoxy technique section 80x40cm for movable legs and.*
2. *Seat made of inner steel and entirely cold foamed with automatic spring return and gravity turnover system (counter-weight):
- upholstered with double stitching on perimeters (squared version);
- upholstered with central stitching on seat (rounded version).*
3. *Backrest made of inner steel and entirely cold foamed with bayonet insertion:
- upholstered with double stitching on perimeters (squared version);
- upholstered with central stitching on backrest (rounded version).*
4. *Backrest cover:
- black varnished sheet steel carter;
- varnished wooden carter.*
5. *Customer's logo, row and seat indicators stiched within the fabric upon customer's choice.*
6. *Armrests:
- entirely cold foamed;
- incorporated writing board with steel structure and upholstered panel.*
7. *Pad:
- upholstered pad;
- black polyurethane pad;
- varnished wooden pad.*
8. *Writing board in HPL with anti-panic joint.*
9. *Covering according to our fabric colour chart or by customer's fabrics.*
10. *Reference regulation:
- En 12727 Fixed to the floor bench
- Only on approval request, 11M class with category L fabric cost an extra 10%.*



Segnafile - Segnaposto - Logo cliente
Row indicator - Placeholder - Customer logo



NOVITÀ - NEW
Personalizzazione cliente
Customer personalization



Possibilità di avere le cuciture di colore diverso dal rivestimento
Possibility to have different seam colour compared to upholstery



Particolare tavoletta scrittoio a scomparsa
Hidden writing board



Particolare tavoletta scrittoio
Writing board



Pad bracciolo imbottito
Padded armrest pad

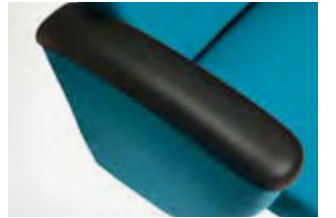

Pad bracciolo in poliuretano
Polyurethane armrest pad



Pad bracciolo in legno
Wooden armrest pad

CONCORDIA

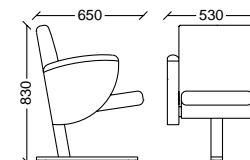

Posto panca mobile sedile e schienale quadro fianco sospeso
Square seat and backrest mobile bench with suspended side

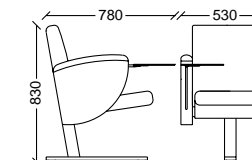

Posto panca mobile sedile e schienale quadro fianco sospeso con tavoletta
Square seat and backrest suspended and mobile bench with writing board

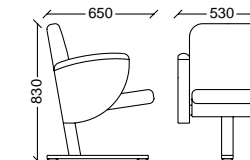

Panca mobile sedile e schienale arrotondato fianco sospeso
Round seat and backrest mobile bench with suspended side

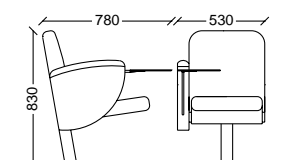

Panca mobile sedile e schienale arrotondato fianco sospeso con tavoletta
Round seat and backrest suspended and mobile bench with writing board

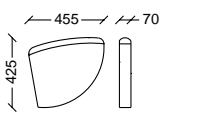

Fianco finale sospeso
Suspended final bench side

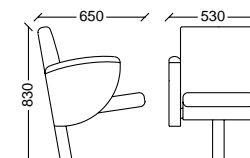

Schienale quadro fianco sospeso
Square backrest on the suspended bench side

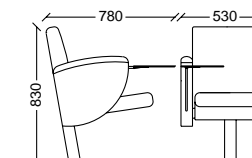

Schienale quadro fianco sospeso con tavoletta
Square backrest on the suspended bench side with writing board

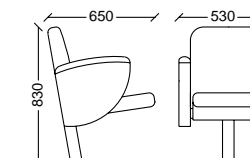

Schienale arrotondato fianco sospeso
Round backrest on the suspended bench side

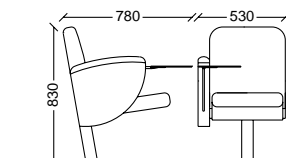

Schienale arrotondato fianco sospeso con tavoletta
Round backrest on the suspended bench side with writing board

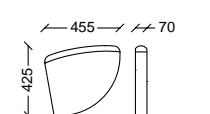

Fianco finale sospeso
Suspended final bench side

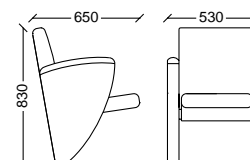

Sedile e schienale quadro fianco a pavimento
Square backrest and seat on the bench side fixed to the floor

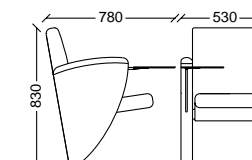

Sedile e schienale quadro fianco a pavimento con tavoletta
Square backrest and seat on the bench side fixed to the floor with writing board

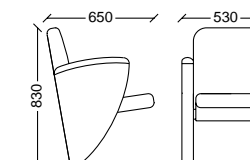

Sedile e schienale arrotondato fianco a pavimento
Round backrest and seat on the bench side fixed to the floor

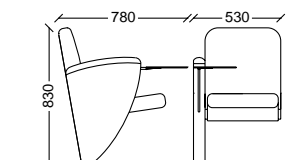

Schienale e schienale arrotondato fianco a pavimento con tavoletta
Round backrest and seat on the bench side fixed to the floor with writing board

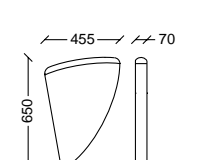

Fianco finale a pavimento
Final bench side fixed to the floor

CONCORDIA



+ TAVOLI



TAVOLI

La serie Tavoli si presenta in varie dimensioni e colori, con base e colonna rigorosamente in acciaio cromato.

The Tavoli series tables are available in various sizes and colours, the base and column are rigorously chromed steel.



TAVOLI - TABLES

1. Base:
 - zavorrata tonda in acciaio cromato, sp. 10 mm;
 - zavorrata quadra in acciaio cromato, sp. 10 mm;
2. Colonna in tubolare di acciaio cromato diametro 50 mm, varie altezze (H1070-H720).
3. Piani:
 - in melaminico colorato 800x800 sp. 30 mm;
 - in melaminico colorato diametro 800 sp. 30 mm;
 - in melaminico colorato 600x600 sp. 30 mm;
 - in melaminico colorato diametro 600 sp. 30 mm.

1. Base:
 - ballast round chromed steel, thickness 10 mm;
 - ballast square chromed steel, thickness 10 mm;
2. Column in tubular chromed steel diameter 50 mm, various heights (H1070-H720).
3. Table tops:
 - in coloured melamine 800x800 H720 th. 30 mm;
 - in coloured melamine diameter 800 H720 th. 30 mm;
 - in coloured melamine 600x600 H1070 th. 30 mm;
 - in coloured melamine diameter 600 H1070 th. 30 mm;

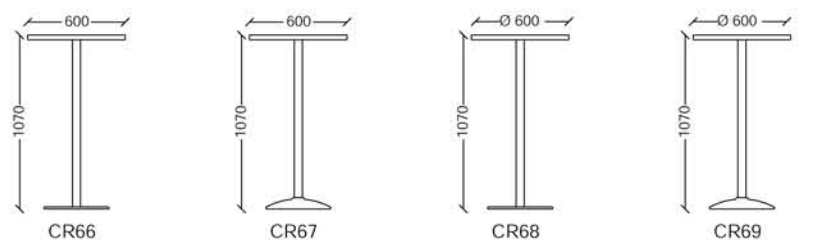
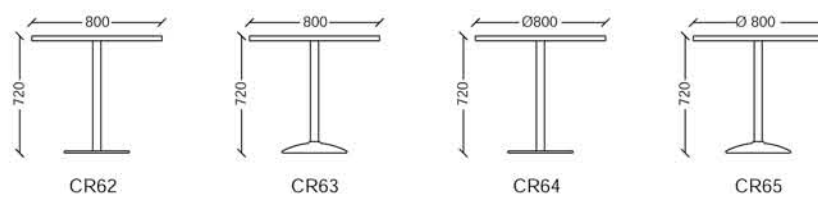

SEDIAKREATIVE

COLLECTION

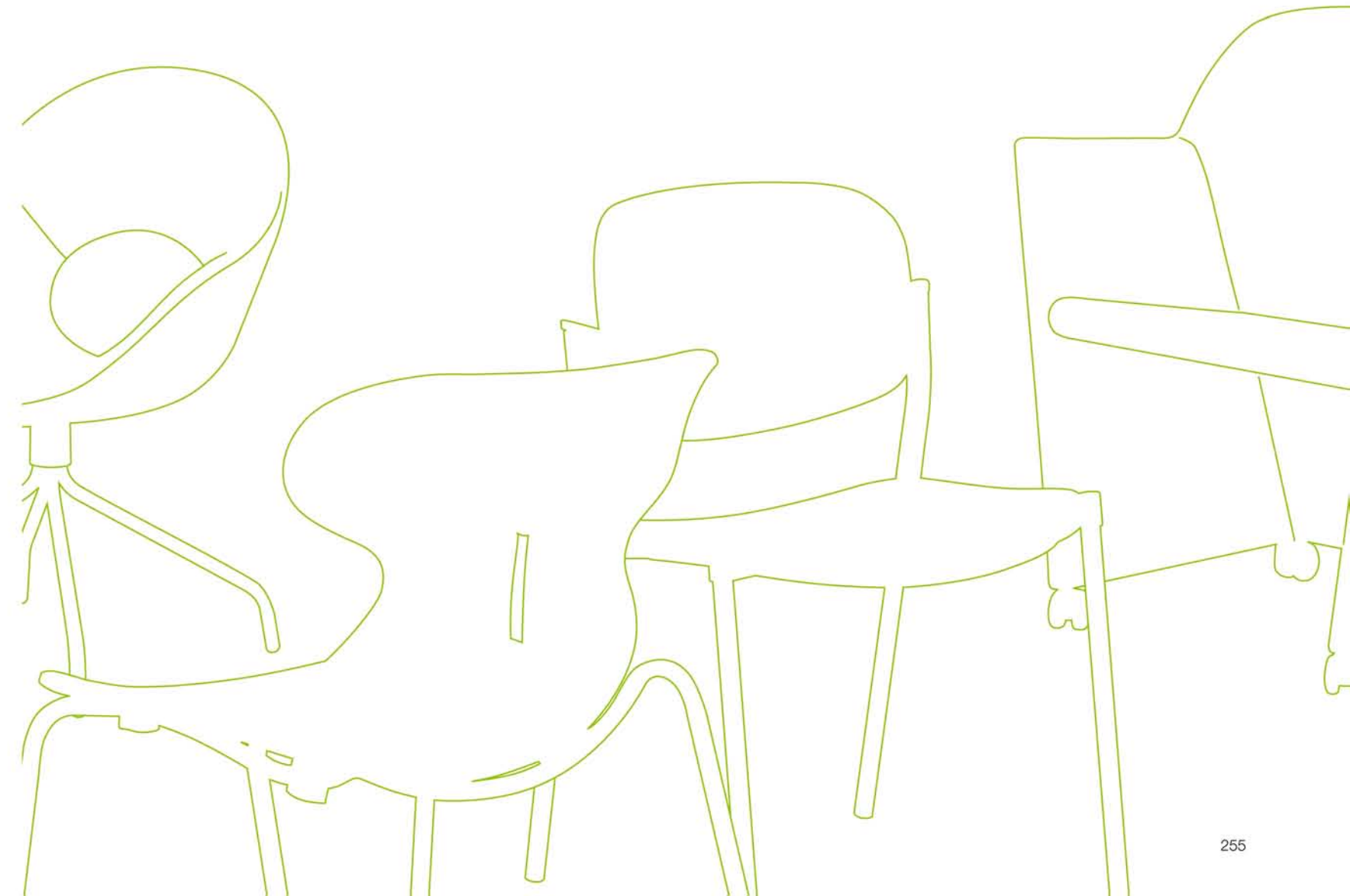

Categoria D
Similpelle Fleur

Category D
Imitation Leather Fleur

Composizione:
79% Pvc - 21% Poliestere
Peso:
Gr/Mq 530,00

Composition:
79% Pvc - 21% Polyester
Weight:
Gr/Sqm 530,00

Categoria D2
Similpelle Fleur Ignifugo

Category D2
Imitation Leather Fleur F.R.

Composizione:
79% Pvc - 21% Poliestere
Peso:
Gr/Mq 530,00

Composition:
79% Pvc - 21% Polyester
Weight:
Gr/Sqm 530,00

Categoria N
Renna Similpelle Traspirante

Category N
Renna Breathable Imitation Leather

Composizione:
80% Cotone
20% Poliuretano
Peso:
Gr/Mq 350,00

Composition:
80% Cotton
20% Polyurethane
Weight:
Gr/Sqm 350,00

Categoria N2
Renna Similpelle Traspirante Ignifuga

Category N2
Renna Breathable Imitation Leather F.R.

Composizione:
80% Cotone
20% Poliuretano
Peso:
Gr/Mq 350,00

Composition:
80% Cotton
20% Polyurethane
Weight:
Gr/Sqm 350,00

Categoria R
Elephant Similpelle

Category R
Polyester 100%

Composizione:
100% Poliestere
Peso:
Gr/Mq 350,00

Composition:
100% Poliestere
Weight:
Gr/Sqm 350,00

Categoria E
Elephant Similpelle

Category E
Elephant Imitation Leather

Composizione:
64% Cotone
36% Poliuretano
Peso:
Gr/Mq 620,00

Composition:
64% Cotton
36% Polyurethane
Weight:
Gr/Sqm 620,00

Categoria Z
Pelle Rigenerata

Category Z
Recycled leather

Composizione:
20% Pelle - 45% Poliuretano
26% Cotone - 9% Polipropilene
Peso:
Gr/Mq 690,00

Composition:
20% Leather - 45% Polyurethane
26% Cotton - 9% Polypropilen
Weight:
Gr/Sqm 690,00

Categoria Pelle
Pelle

Category Pelle
Leather

Composizione:
100% Pelle naturale primo fiore

Composition:
100% Genuine full flower leather

NB: Tutti i colori sono validi per la categoria normale ed ignifuga - All of the colours are also available in the flame retardant version

D-D2

D Similpelle Fleur
Imitation Leather Fleur

D2 Similpelle
Fleur Ingnifugo
Imitation Leather
Fleur F.R.

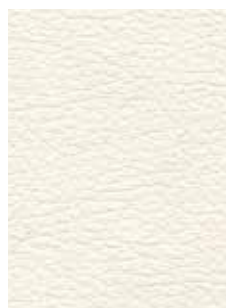

988



982



986



987



989



984



991

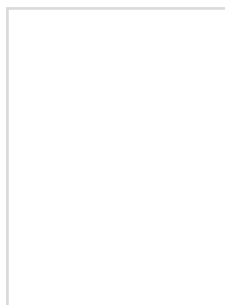

981

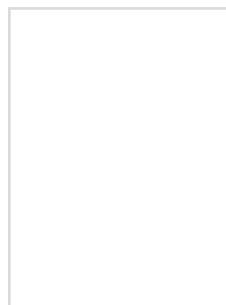

983

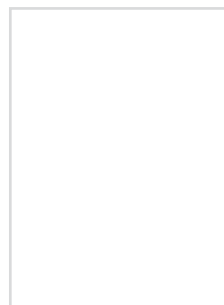

992

NB: Tutti i colori sono validi per la categoria normale ed ignifuga - All of the colours are also available in the flame retardant version

N-N2

N Renna Similpelle
Traspirante
Renna Breathable
Imitation Leather

N2 Renna Similpelle
Traspirante Ingnifuga
Renna Breathable
Imitation Leather F.R.



60



67



61



69



62



65



68

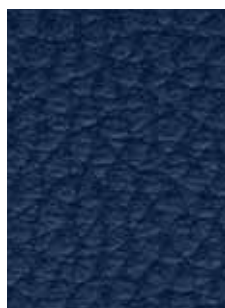

66



71



64

R

Poliestere 100%
Polyester 100%

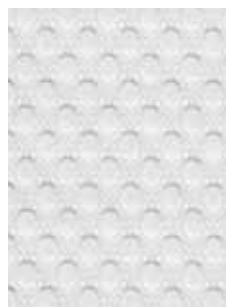

201

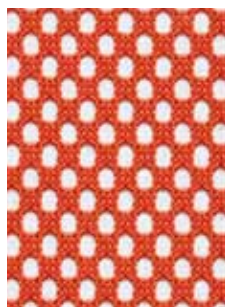

202



203



204

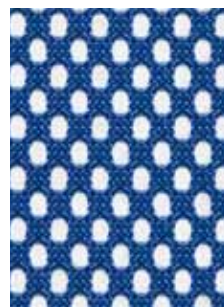

205



206

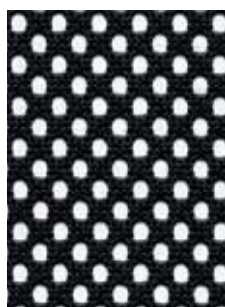

207

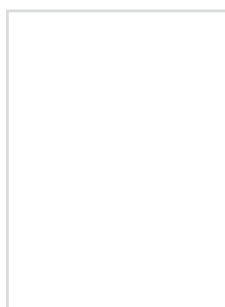

208

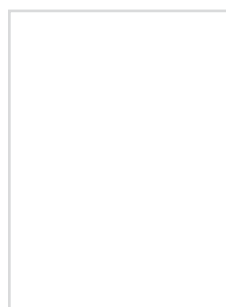

209

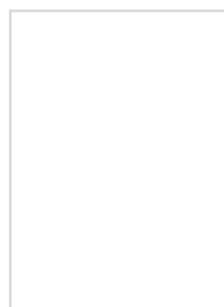

210

E

Elephant Similpelle
Elephant Imitation
Leather



430



431



432

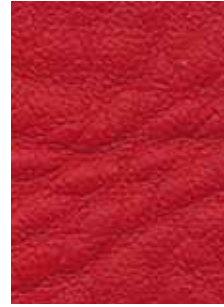

433



434



435



436

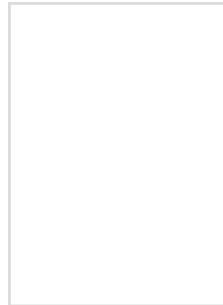

437

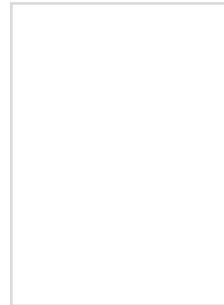

438



439

Z

Pelle rigenerata
Recycled leather



01



02



03



04



05



06

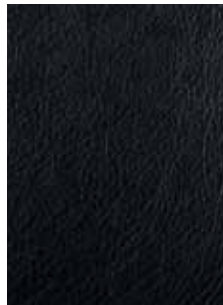

07



08

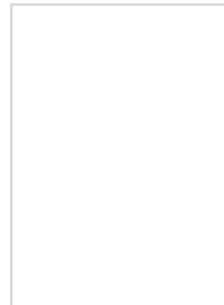

09



10

PELLE

Pelle
Leather



600



605



603



607



601



104

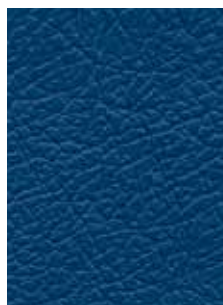

105

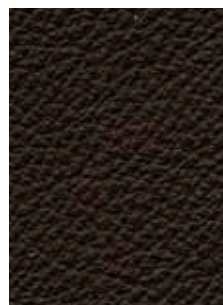

602

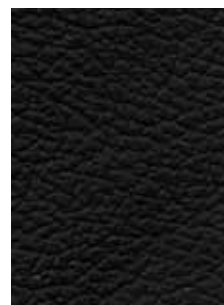

611



604



Shop1:

**6, Charilaou Trikoupi
P.O.Box 61387
8133, Paphos - Cyprus
Mob: (+357) 99647447
Tel: (+357) 26811990
Fax: (+357) 26935566**

Shop 2:

**6, Anthypolochagou
Georgiou Savva, Shop A&B
8201, Geroskipou - Cyprus
Mob: (+357) 99647447
Tel: (+357) 26967600
Fax: (+357) 26967007**

sedia@sedia.com.cy

www.sedia.com.cy